

**JOURNAL OF THE
VIOLA DA GAMBA SOCIETY
OF AMERICA**

Volume 45

2009–10

EDITOR: Robert A. Green
ASSOCIATE EDITOR: Jean Seiler
REVIEWS EDITOR: Janet Scott
PRODUCTION EDITOR: David Dreyfuss

EDITORIAL BOARD

Richard Charteris Thomas G. MacCracken
Mary Cyr Richard Taruskin
Roland Hutchinson Frank Traficante
Ian Woodfield

CONTENTS

Viola da Gamba Society of America	3
Editorial Note	4
Toronto's Hart House Viols Joëlle Morton	5
Twin Viols: Evidence for Serial Production in the Workshop of Nicolas Bertrand Thomas Fitz-Hugh Mace	77
Recent Research on the Viol. Ian Woodfield	122
Review	
Joseph Haydn, <i>24 Divertimenti a tre für Baryton (Viola da Gamba, Violine) Viola und Violon- cello</i> , <i>28 Divertimenti a tre für Baryton (Viola da Gamba, Violine) Viola und Violoncello</i> , ed. G. & L. von Zadow Roland Hutchinson	125
Contributor Profiles	135

Publications of the Society are obtainable through membership. Inquiries concerning membership, circulation, advertisements, and availability of back issues should be addressed to the Executive Secretary: Alice Brin Renken, 4440 Trieste Drive, Carlsbad, CA 92008; e-mail <arenken@sandwich.net>.

The *Journal* editors welcome for consideration articles pertaining to the viols and related instruments, their history, manufacture, performers, music, and related topics. Articles, correspondence, and materials for review should be sent to the editor: Robert A. Green, 5165 E. Heritage Woods Rd., Bloomington, IN 47401 or via e-mail to <rgreen1965@aol.com>. Authors should consult the *Chicago Manual of Style*, 15th Edition, for matters of style. Articles and reviews should be submitted on disk specifying the computer and program used, or sent to the e-mail address above. Figures, diagrams, photographs, and music examples should be submitted separately as publication-ready digital image files or black-and-white glossy prints. Please consult the Editor if there is any question as to appropriate format, size, or resolution.

Cover design by George Glenn, founder of the Viola da Gamba Society of America.

Copyright © 2010 by the Viola da Gamba Society of America.

Printed in the United States of America.

ISSN 0507-0252

VIOLA DA GAMBA SOCIETY OF AMERICA

4440 Trieste Drive
 Carlsbad, CA 92008
 post@vdgsa.org
 http://vdgsa.org

The Viola da Gamba Society of America is a not-for-profit national organization dedicated to the support of activities relating to the viola da gamba in the United States and abroad. Founded in 1962, the VdGSA is a society of players, builders, publishers, distributors, restorers, and others sharing a serious interest in music for viols and other early bowed string instruments. VdGSA members receive a quarterly newsletter and this annual journal, and have access to the many activities and valuable resources of the Society. The website provides additional information on the annual Conclave, instrument rentals, the microfilm lending library for researchers, and other offerings.

OFFICERS

<i>President</i>	Wendy Gillespie
<i>Vice President</i>	Marie Dalby
<i>Executive Secretary</i>	Alice Brin Renken
<i>Treasurer / Membership</i>	Ken Perlow
<i>Past President</i>	Suzanne Ferguson

BOARD OF DIRECTORS

Term expiring 2010

Susan Marchant, Christine Spencer, Dominik Zuchowicz

Term expiring 2011

Sarah Mead, Peter Payzant, Lee Talner

Term expiring 2012

Jane Hershey, Julie Jeffrey, Heather Spence

Directors-at-Large

Chris Briden, William Pannill, Kathy Schenley, Jean Seiler,
 Kathleen Spencer

EDITORIAL NOTE

The two articles in this issue of the journal approach the viol from an organological point of view (as opposed, say, to musical analysis or performance practice). The first article explores the cultural impact of the Canadian collection of viols now in the Hart House at the University of Toronto. The article reveals the pivotal role these instruments have played in stimulating the performance of early music in the area. While the instruments have been the focus of major performers, such as Peggy Sampson, they owe their presence and their availability to the collective vision of major figures in the political, artistic, and economic life of Canada.

The second article focuses on the construction methods used by Nicolas Bertrand, a major figure in the development and construction of the seven-string bass viol at the end of the seventeenth and beginning of the eighteenth centuries. The author is a luthier who enters into a dialogue with the evidence found in two surviving instruments to tease out the surprisingly pragmatic way in which Bertrand approached his business.

Although these articles approach their subjects in different ways, they have several things in common. Both articles make the case for the cultural impact and value for research that instruments in public and private collections possess. Some of the instruments in both articles have suffered from alterations over the course of their lives, resulting in the loss of valuable information. Finally, both deal, at least in part, with instruments by the preeminent French maker Nicolas Bertrand, which underscores the pivotal role this maker played in the development of the viol in France.

Ian Woodfield continues to provide his bibliography the most recent viol publications. Finally, there is an extensive review of new performing editions of Haydn's baryton trios. Its thorough treatment of available editions and the questions they raise make it required reading for anyone wishing to play this music on the baryton, viola da gamba, or violin(!).

Robert A. Green

TORONTO'S HART HOUSE VIOLS

Joëlle Morton

Abstract

There is an exquisite collection of old viols owned by Hart House, a social and recreational facility at the University of Toronto. The instruments are in playing condition and were used regularly by Toronto players from the 1930s through the 1980s, after which Hart House made an effort at conservation, having them installed in a humidity-controlled presentation box that was unveiled in May 1999. Over the last four years, there has been renewed use of the instruments, and this recent activity has prompted questions about their origins and history. The queries have been problematic because until now, the collection has never been intensively studied or documented. This article details the provenance of the viols and use over the past century. The instruments have touched the lives of a large number of individuals, some well known, as well as a number whose names have not previously been discussed in the context of the “early music movement.” A thorough description of the collection also has tremendous cultural relevance.

Hart House in Toronto is the proud possessor of a cultural gem: a chest of historic viols. How did these wonderful instruments come to be here, and what has been their significance to the city and the early music world? This article brings together for the first time the details of their story.¹

¹ I am very grateful for the assistance and kind support of many individuals who provided me access to what are otherwise private documents and archives. At Hart House, Zoe Dille (Coordinator of Programme and Innovation), Lancy Marshall (Director of Programme), Louise Cowin (Warden), Amanda Greener (Assistant to the Warden), Michel Mercereau (Marketing Manager), Chris Lea (Facilities Manager), and Jerry Horton (Host of the Gallery Grill) were unfailingly encouraging, supportive, and gratifyingly excited to learn about the collection that has graced their hallowed halls for so many decades. At the Arts and Letters Club, Scott James (Archivist) and Margaret McBurney (Historian) were generous sharing information and photos from both the Club's official documents and also their individual private research. Loryl MacDonald (Records Archivist) at the University of Toronto, Marie Korey (Librarian) at Massey College, as well as Ken Puley (Radio Archives) and Lorne Shapiro (Music Library) at CBC, were most helpful. Thomas G. MacCracken, John Pringle, Joseph Peknik III, Michael Grunsky, Ingrid Fistell, Macey Cadesky, Klement Hambourg, Joyce Gundy, and Thomas Georgi shared numerous insights and

In 1910 an English cathedral organist, W. Howard Head, arrived in Vancouver, bringing with him a large number of personal effects, including an unusual old chest, which had been specially altered to accommodate six antique viols and their bows.² The



The Chest of Viols, c.1926.

(Photo courtesy of the University of Toronto Archives, Vincent Massey Personal Records, B1987-0082/082(01))

contacts, which greatly facilitated my filling out biographies of historical figures and identifying other relevant instruments. In the course of my research, I was in touch with every person I could possibly reach who has had an association with the Hart House viols over the years. These individuals are too numerous to mention, but I wanted to offer them my gratitude and say that if I have omitted details they provided, it was only for the sake of limiting the length of what is already a sizable document.

²University of Toronto Archives, Vincent Massey Personal Records, B1987-0082/082(01): Memorandum, date unknown, but autumn 1926 at the latest. This document was seemingly prepared by Vincent Massey, as an information sheet to advertise the viols at a time when he wished to sell the collection. It is the only source in which Head's profession is mentioned as "cathedral organist." It has not been possible to confirm or deny Head's musical activities or pedigree. However, it seems unlikely that Massey would have fabricated this detail about Head; perhaps he knew some things about Head through written materials that no longer survive, or by word of mouth.

chest was made of English brown oak, and was likely originally conceived as a dowry box, since it bears the inscription “Margret Platts 1673.” Head found and bought the chest in London, believing it to be an ancestral heirloom; Platts was his mother’s maiden name.³ “Following the old custom,” Head had the chest “lined with zinc and plush ... and nests were made to hold the instruments” in three layers.⁴ As for the viols, they were “not only beautiful museum pieces, but also playing instruments in perfect condition”⁵ and had been collected “over a long course of years, and with great love and considerable knowledge ... with cruel care and at some cost.”⁶ At that time, the names of the makers of the viols were not ascribed, nor were the instruments described with precise sizes/tunings. Head, however, prized them greatly.

The dates and locations of his birth and death are unknown, but W. Howard Head was of noble English heritage, related to 1st Baronet Sir Francis Bond Head (1793–1875), Lieutenant Governor of Upper Canada during the Rebellion of 1837, and 8th Baronet Sir Edmund Walker Head (1805–68), Governor General of the British North America 1854–61.⁷ During his time in Canada, Head mingled with the elite of Canadian society, describing himself as friends with the Eaton family, department store moguls of Toronto, and George Pedlar, tin and sheet metal purveyor in

³ UofT 082(01): Memorandum. Like Head’s profession, this document is the only source to identify the name on the chest as being that of Head’s mother, and to specify that the chest was purchased in London. Head himself asserted that the chest belonged to his family, but the extra details come via Vincent Massey.

⁴ *Ibid.*

⁵ *Ibid.*

⁶ UofT 082(01): Letter of November 27, 1925 from W. Howard Head to Bertram Forsyth, Esq., redirected to Vincent Massey’s attention on December 15, 1925.

⁷ Burke’s Peerage lists a William Howard Head, of the Head family line ennobled with the title of Viscount, born September 28, 1864. This man was the first child, and therefore eldest son, of Jeremiah Head of Coatham, Yorks and Rebecca Ingram and married Virginia Zillian, daughter of Robert Aymer of Denver, Colorado on September 2, 1901. The name and date sound plausible enough; however, this person is from a different line of peerage from the two Baronets, which directly contradicts Head’s statement to Vincent Massey in a letter of February 18, 1926 (UofT 082(01)). Head’s identity has not been found nor identified in any other sources, such as city directories or census records.

Oshawa.⁸ It has not yet been ascertained if or where he trained and performed as an organist,⁹ but Head was an avid collector of ancient instruments, and his collecting activities date roughly to the period between 1899 and 1938.¹⁰ The Vancouver chest aside, by 1929 Head owned a tenor viol by John Rose that eventually passed to the noted French musicologist and collector Mme. de Chambure and later went with the rest of her instruments to the Musée de la Musique, Paris. Canon Francis W. Galpin introduced and described that instrument in December 1929, saying it belonged to “my friend, Mr. Howard Head of 1 Woodstock Studios, Bedford Park, W4.”¹¹ In June 1931, Head placed an advertisement in the journal *Notes and Queries*, requesting information about the whereabouts of the bass viol depicted in Thomas Gainsborough’s painting of Anne Ford.¹² Head’s collecting also extended beyond viols. On November 30, 1927, he wrote a collegial letter to the collector of wind instruments Dayton C. Miller in Cleveland, Ohio, enclosing a 1707 pencil drawing “The Bass Viol Player” by the French engraver Bernard Picart (1673–1733).¹³ In the decade that followed, Head supplied Miller with thirty-four important old in-

⁸ UofT 082(01): Letter of November 27, 1925 from W. Howard Head to Bertram Forsyth, Esq.

⁹ There is no mention of W. Howard Head in the Royal College of Organists archives. I am grateful to Andrew McCrea, Director of Academic Development at the Royal College of Organists, for checking the archives on my behalf.

¹⁰ 1899 is the date of George St. George’s restoration and repair of the Hart House viols based on dates written on repair labels inside several instruments, though it is not known if it was W. Howard Head who commissioned and paid for that work. July 1938 is the date of Head’s final transaction with Dayton Miller in Cleveland.

¹¹ *Under the Dome* (newsletter of the Bethlem Royal Hospital) 36, no. 152 (December 25, 1929): 86. I am grateful to Colin S. Gale, Archivist at Bethlem Royal Hospital, for providing me copies of this publication.

¹² *Notes and Queries* 160 (June 27, 1931): 460.

¹³ The image is located at the Library of Congress, Music Division, Dayton C. Miller Flute Collection: Box L, ID# 0148. (Reproductions of that image are available from the Library of Congress’s online gift shop: <http://www.loc.gov/shop>, at \$28 for an 8x10.)

struments: flutes, recorders, flageolets, and a pipe and tabor.¹⁴ Unfortunately, few other details concerning W. Howard Head have been found, and the provenance of his instrument acquisitions is more or less a complete mystery.

In 1915 Head found himself “financially crippled because of the war,” needing to sell many of his effects in order to return to England.¹⁵ He pawned the chest of viols to a Vancouver antiques dealer, Edward Chapman. Head later claimed that the viols were only being held “in escrow, with the idea of giving me a reasonable opportunity to redeem them, and at any rate [they] were not to be sold unless and until they had first been offered back to me at equal price.”¹⁶ It is hard to say if Chapman’s dealings were intentionally crooked or not, but if such was indeed the agreement, he was remiss in apprising Head about future inquiries.¹⁷ In the autumn of 1918 a prospective buyer, Roy Mitchell, appeared. Director of Motion Pictures for the Canadian Department of Public Information, and an actor and theater director in Toronto, Mitchell had a particular passion for Shakespeare and would almost certainly have been drawn to the viols, envisioning the possibility of recreating the music of Shakespeare’s period in some of his many projects. Mitchell entered into negotiations for the collection.

At home in Toronto, Roy Mitchell recruited a group of friends to contribute towards the \$1,500 purchase price; each “subscriber” joined by paying \$100, a substantial sum at the time.¹⁸ These investors were friends and colleagues from Toronto’s Arts and Letters Club, an exclusive men’s society founded in 1908, which was

¹⁴ Miller’s collection is now located at the Library of Congress, in Washington, DC: Library of Congress, Music Division, Dayton C. Miller Flute Collection. The thirty-four wind instruments that Miller acquired from W. Howard Head were purchased over the course of twenty-one transactions dating between December 7, 1928 and July 30, 1938.

¹⁵ UofT 082(01): Letter of November 27, 1925 from W. Howard Head to Bertram Forsyth, Esq.

¹⁶ *Ibid.*

¹⁷ *Ibid.* This letter indicates Head was not advised about the potential sale of the chest to the Torontonians, and that he only learned of it after the fact.

¹⁸ UofT 082(01): Letter of March 18, 1929 from Vincent Massey to Robert A. Defries. Unless otherwise noted, sums are expressed in Canadian dollars.



Roy Mitchell in his Hart House office, 1921.
(Photo courtesy of the Arts and Letters Club Archives)¹⁹

at the time a hub for Toronto's cultural elite. Its members were both practitioners (writers, architects, musicians, painters, sculptors) and supporters of the arts (referred to as "non-professionals") who regularly met at the Club for meals, cultural events, and general socializing. Mitchell was at that time the "driving force behind the theatrical activity of the Club [where] dramatic dinner entertainment [was] a tradition."²⁰ Though none of his subscribers was a musician, the initiative clearly appealed to the youngest and brightest of Toronto's cultural society; from today's perspective, the list reads like a *Who's Who* of some of the most famous Canadians in history. In short order, Mitchell signed on seven friends: a

¹⁹ I am grateful to Scott James, Archivist at the ALC, for his assistance providing this photo and the one of Vincent Massey.

²⁰ Renate Usmiani, "Roy Mitchell: Prophet in Our Past," *Theatre Research in Canada* 8, no. 2 (Fall 1987).

painter and leader of the renowned Group of Seven²¹ Lawren Harris, architect Henry Sproatt, engineer Ernest R. Rolph, lawyer Robert L. Defries, George J. McMurtrie (known only as a “non-professional” at the Club), ophthalmologist and avid patron of the arts James M. MacCallum, and the most important subscriber, Vincent Massey.²² Vincent Massey was Secretary-Treasurer of the Massey-Harris Company and Dean of Victoria University. He later served as the first Canadian-born Governor General of Canada (1952–59). He is now perhaps best remembered for his leadership of the “Massey Commission” (1949–51), a group that advocated the creation of a government-sponsored organization that would formally define, foster, and support Canadian culture, resulting in the establishment of the Canada Council for the Arts. It is possible that Mitchell and Massey knew each other from the Arts and Letters Club, but Vincent Massey’s personal diary indicates he first formally met Roy Mitchell and became aware of his credentials over lunch at Toronto’s Racquet Club, on October 29, 1918.²³ The two men socialized regularly in the months after that time.²⁴ Some of their subsequent meetings were surely a result of the fact that Massey was courting Mitchell to become the founding Director for the Hart House Theatre, scheduled to open in the fall of 1919. In any case, Massey signed on as the eighth investor in the viols.

In the meanwhile Chapman, the antiques dealer in Vancouver, had become impatient and skeptical of receiving his money, and behind the Torontonians’ back he advertised and shipped the col-

²¹ The Group of Seven was an organization of Canadian painters, founded in 1920 by Franklin Carmichael, Lawren Harris, A. Y. Jackson, Franz Johnston, Arthur Lismer, J. E. H. MacDonald, and Frederick Varley. For more information, see Appendix 2.

²² UofT 082(01): Letter of April 11, 1932 from Vincent Massey to Ernest MacMillan. See Appendix 2 for more complete biographical information about the subscribers, with the exception of McMurtrie, about whom nothing further is known.

²³ University of Toronto Archives, Vincent Massey Personal Records, B1987-0082/302: Vincent Massey’s personal diary for the year 1918.

²⁴ UofT 082/302: Diaries from 1918 and 1919.

lection to the Metropolitan Museum in New York.²⁵ Through this entire saga, W. Howard Head seems not to have been contacted, let alone offered the opportunity to redeem his investment.²⁶ In Toronto only eight individuals had thus far signed on to make the purchase, but on April 23, 1919, Vincent Massey stepped forward representing the Massey Foundation (a family enterprise founded in memory of his father, Chester) with a check for the \$700 balance outstanding.²⁷ Payment having been made in full, the collection was sent to Toronto from New York and lodged, “by the common consent of the original subscribers, in the Arts and Letters Club library, which was a meeting-ground for most of those interested.”²⁸ The Massey Foundation covered its insurance.²⁹

The Viols Come to Toronto

At the time of the chest’s arrival in Toronto, most of those concerned were preoccupied with the completion and inauguration of a huge new cultural facility, Hart House, a social/recreational building being erected at the University of Toronto. Named for Vincent Massey’s grandfather Hart Almerrin Massey, Hart House was a grand Collegiate Gothic edifice planned and supervised by Vincent Massey and financed by the Massey Foundation. The building itself was designed and constructed by Henry Sproatt and Ernest Rolph and decked out in lavish style with paintings, sculptures, and all manner of decoration by the most prominent Canadian artists of the time, not the least of whom were Lawren Harris

²⁵ UofT 082(01): Memorandum. No supporting records exist for the shipping of the chest to/from New York, nor documentation to show that the Metropolitan Museum did in fact intend to make the purchase. However, it seems unlikely that Vincent Massey would have fabricated such a story. I am grateful to Joseph Peknik III at the Metropolitan Museum for checking their archives on my behalf.

²⁶ UofT 082(01): Letters of November 27, 1925 and February 18, 1926 from W. Howard Head to Bertram Forsyth and Vincent Massey.

²⁷ UofT 082(01): Letter of March 9, 1932 from T. A. Morrow at the National Trust Co. to Vincent Massey confirms that the Massey Foundation made the \$700 payment on April 23, 1919 for the collection.

²⁸ UofT 082(01): Letter of March 18, 1929 from Vincent Massey to Robert A. Defries.

²⁹ UofT 082(01): Letter of April 11, 1932 from Vincent Massey to Ernest MacMillan.

and many of the other members of the Group of Seven. At the same time, Roy Mitchell was busy with the organization of the Hart House Theatre, which in short order would become renowned for its productions of both historical drama and modern works. In describing his mission for Hart House at its inauguration on November 11, 1919, Vincent Massey said:

The House is intended to represent the sum of those activities of the student which lie outside the curriculum. These activities are not unimportant; indeed, the truest education requires that the discipline of the classroom should be generously supplemented by the enjoyment, in the fullest measure, of a common life. A common life, of course, presupposes common ground.³⁰

It was surely this philosophy, in combination with a genuine altruistic and philanthropic spirit, among the gentlemen involved with Hart House and the Arts and Letters Club that motivated their investment in the viols.



Hart House, c.1921.

(Photo by G. D. Haight, courtesy of the Hart House Archives)

³⁰ Karen A. Finlay, *The Force of Culture: Vincent Massey and Canadian Sovereignty* (Toronto: University of Toronto Press, 2004), 34.

From the time of its arrival in Toronto, Vincent Massey took most of the initiative and responsibility for the collection. While he was by far the most heavily invested, he also had a strong vision of how the viols might be put to good use. According to Massey, they were purchased with the “desire of setting up a Society of Ancient Instruments like that of the renowned Dolmetsch family in England. The intention was to find musicians in Toronto who could play the viols and give concerts of old music.”³¹ Massey had attended university at Balliol College in Oxford from 1911 to 1913, and it is entirely possible that he had occasion to meet or hear members of the Dolmetsch family during this period. Regrettably, Massey’s vision of an early music society in Toronto took some time to materialize. In 1926 he lamented, “The technique of the viol is quite distinct from that of the violin and no musicians [have yet been] found who could give the necessary time to it. Years passed and the chest was rarely, if ever, opened.”³² In consultation with the other original subscribers, Massey “agreed to the wisdom of selling the collection if a good price could be obtained.”³³ To this end, he wrote a brief history and description and had the viols appraised by Auguste Delivet, a Paris-trained luthier in Toronto employed by R. S. Williams & Sons Co. Limited, a firm that both made and sold musical instruments. In addition he obtained black-and-white photographs of the instruments and fielded a number of inquiries from interested parties. It is fortunate that Massey was a meticulous record keeper and that he went on to become a celebrated public figure; most of the documents that enable the creation of this historical narrative are part of the Vincent Massey Archives, at the University of Toronto.

In 1926, Massey believed the collection to be valued between \$8,000 and \$10,000,³⁴ but he would have accepted as little as

³¹ UofT 082(01): Letter of March 18, 1929 from Vincent Massey to Robert A. Defries.

³² Ibid.

³³ Ibid.

³⁴ Hart House, Board of Stewards minutes, 190th meeting, September 29, 1927, p. 2.

\$2,500 for it.³⁵ The collection generated a fair amount of interest; some of the inquiries are worth describing. Lotta van Buren (1877–1960) was a scholar, player, collector, and restorer of instruments then living in New York. She had a particular fondness for viols; the most important instrument of her collection was the so-called “Handel viol” now at Brigham Young University in Provo, Utah, which she acquired and described in the course of her correspondence with Massey.³⁶ In the fall of 1926, Van Buren expressed a strong interest in the viols but was unable to pay the asking price.³⁷ In May 1927, inventor and automobile baron Henry Ford (1863–1947) heard about the viols and expressed interest in learning more, but nothing seems to have come of it.³⁸ And in January 1928, Constance E. Hamilton of Toronto inquired about the viols on behalf of the Dolmetsch Foundation in England.³⁹ Vincent Massey responded with an asking price of \$5,000.⁴⁰ The eminent Tudor scholar H. Edmund Fellowes (1870–1951), who visited Toronto as a guest lecturer at the University on a number of occasions, is said to have viewed the collection for the Dolmetsch Foundation on March 4, 1929.⁴¹ But nothing seems to have come of this either. It was during this period that a letter reached Massey out of the blue from W. Howard Head (by then living in Bedford Park, London), saying that he had gotten wind of the viols’ transfer to Toronto, explaining the circumstances of his leaving the

³⁵ UofT 082(01): Vincent Massey letters of December 28, 1926 to Lotta van Buren and June 9, 1927 to Milton Blackstone.

³⁶ UofT 082(01): Letter of December 29, 1926 from Lotta van Buren to Vincent Massey.

³⁷ UofT 082(01): Letter of March 7, 1927 from Lotta van Buren to Vincent Massey.

³⁸ UofT 082(01): Letter of May 28, 1927 from Milton Blackstone to Vincent Massey.

³⁹ UofT 082(01): Letter of January 25, 1928 from Constance Hamilton to Vincent Massey.

⁴⁰ UofT 082(01): Letter of February 1, 1928 from Vincent Massey to Constance Hamilton.

⁴¹ Hart House Viols File (located in the Warden’s office at Hart House): Report prepared by A. Hozack, dated May 23, 1975. No other documentation about Fellowes’s visit has been found.

viols in Vancouver, and asking how he might get them back.⁴² Details of Massey's reply have survived by inference in the subsequent reply from Head, who expressed bitter disappointment that the Torontonians had invested such a large sum, which he was unable to raise in order to buy them out.⁴³ In the end, none of the parties interested in the viols during this time were able to make the purchase, and so the instruments remain to this day in Toronto.

During the last week of August 1927, Vincent Massey moved the viols across town from the Arts and Letters Club to Hart House,⁴⁴ justifying the relocation by claiming that "in a fire-proof building" they would incur a lower insurance premium.⁴⁵ At Hart House they were installed in the Music Room and entrusted to the care of the Warden, J. Burgon Bickersteth. Hart House was very pleased to take charge of the collection, and within a matter of weeks H. J. Davis, Chairman of the Hart House Music Committee and also part of the English Department at the University of Toronto, wrote to Vincent Massey to thank him:

The chest was recently opened under my supervision, and we found the instruments in excellent condition; they are indeed almost fit for immediate use. We are not quite sure if it was your intention that they should ever be used, even if we could discover someone able to play them. But it seems a pity that the Members of

⁴² UofT 082(01): Letter of November 27, 1925 from W. Howard Head to Bertram Forsyth, director of the Hart House Theatre, who then forwarded it to Vincent Massey.

⁴³ UofT 082(01): Letter of February 18, 1926 from W. Howard Head to Vincent Massey.

⁴⁴ University of Toronto Archives, Vincent Massey Personal Records, B1987-0082/107(01): Letter of August 24, 1927 from Vincent Massey to J.B. Bickersteth: "In confirmation of our conversation of a few moments ago...the antique oak chest containing a concert of six old viols together with bows and other equipment will be delivered in the course of the next few days to be in the custody of the Stewards of Hart House on loan from its owners. The articles in question are the property of the Massey Foundation together with a few private individuals. It will probably be dispensed of in the course of time, but meanwhile I am glad to know through you that Hart House will be glad to have them as part of the equipment of the Music Room."

⁴⁵ UofT 082(01): Letter of April 11, 1932 from Vincent Massey to Ernest MacMillan. In another document in UofT 082(01), a letter dated August 30, 1927 from N. Fraser at the National Trust Insurance Department advised Vincent Massey that the viols had been moved to Hart House and insured for \$3,000.

the House should not know of their existence and the Music Committee [has] suggested that I should ask your permission to exhibit them—with due care—in the House. We could then invite an expert to come and talk about them, and illustrate the special quality of 17th century chamber music in England. It would be valuable, I think, not only for those who are keen on music, also for all students who are interested in the life and literature of England at this time. With the help of Mr. Ernest MacMillan I am trying other little experiments of this sort in the University this year in connection with English Studies; and this would form a very delightful addition to them.⁴⁶

Massey immediately wrote back expressing delight at these suggestions.⁴⁷

The removal of the viols from the Arts and Letters Club caused something of an uproar. One of the individual investors, Robert L. Defries, Treasurer at the Arts and Letters Club, argued he had never been consulted about the relocation,⁴⁸ even though it was not until February 1929 that he noticed and remarked on their absence.⁴⁹ There followed a lengthy discussion between Massey and the Arts and Letters Club that took six and a half years to resolve. In brief, it seems that some of the original subscribers were under the impression that Roy Mitchell had instigated the purchase of the instruments “by members of the Arts and Letters Club with the idea that they would remain in its possession and ultimately become its property.”⁵⁰ Massey had a different understanding of the background, both as a single shareholder and on behalf of the Massey Foundation.⁵¹ The correspondence back and forth was vo-

⁴⁶ UofT 082(01): Letter of November 28, 1927 from H. J. Davis to Vincent Massey.

⁴⁷ UofT 082(01): Letter of December 17, 1927 from Vincent Massey to H. J. Davis.

⁴⁸ UofT 082(01): Letter of March 7, 1929 from R. L. Defries to J. B. Bickersteth.

⁴⁹ Arts and Letters Club Executive Committee minutes of February 5, 1929 read: “Mr. Defries reported that the valuable chest of viols purchased some years ago is missing from the Club.”

⁵⁰ UofT 082(01): Letter of April 3, 1929 from R. L. Defries to Vincent Massey.

⁵¹ UofT 082(01): Letter of April 11, 1932 from Vincent Massey to Ernest MacMillan.



Vincent Massey (foreground) in 1922, at that time President of the Arts and Letters Club Executive Committee, with (l-r) George Locke (City Chief Librarian), Robert Gagen (artist), George Reid (artist).

(Photo courtesy of the Arts and Letters Club Archives)

luminous and heated, with the Arts and Letters Club looking to claim full possession. The individual subscribers, Massey included, were prevailed upon to deed their shares to the Club; by

the summer of 1932, all had done so.⁵² But Massey refused to turn over his Foundation's portion, and instead, on May 16, 1932, legally transferred it to Hart House.⁵³ Desiring to wash his hands of the entire matter, Massey insisted that all future discussions about ownership, insurance, and usage would have to take place directly between the Arts and Letters Club and Hart House.⁵⁴

Playing the Viols

In the meanwhile, musicians had at long last been found to play the viols. Over the summer of 1931, Hart House records indicate that members of the Conservatory String Quartet had each borrowed an instrument to practice, so they could prepare a program of seventeenth-century music to be performed the following season on the Friday afternoon recital series at Hart House.⁵⁵ A classically trained ensemble-in-residence formed in 1929 by Ernest MacMillan, Principal of the Toronto Conservatory of Music and conductor of the Toronto Symphony Orchestra, the Conservatory String Quartet members were Elie Spivak, Ukrainian violinist, at the time newly appointed to the TCM faculty; Harold Sumberg, another TCM teacher and principal second violin in the TSO; Donald Heins, assistant conductor of the TSO, on viola; and Joseph Leopold "Leo" Smith, teacher of theory, history, composition, and cello. The Quartet's debut on the viols took place at Hart House on January 29, 1932. The program was primarily Elizabethan music, "ably supported by Miss Frances Duncan at the harpsichord," the latter instrument borrowed from T. Eaton Co. for the event, which was "most successful and extremely well at-

⁵² UofT 082(01): Letter of June 3, 1932 from G. J. McMurtrie to R. L. Defries indicates that McMurtrie is the final subscriber to turn over his share to the Arts and Letters Club.

⁵³ UofT 082(01): Letter of May 19, 1932 from Terence Sheard at the National Trust Company to Vincent Massey, advising him that the Massey Foundation's interest in the chest of viols has been formally transferred to Hart House.

⁵⁴ UofT 082(01): Letter of April 19, 1932 from Vincent Massey to R. L. Defries.

⁵⁵ Hart House Music Committee minutes of October 5, 1931.

tended.”⁵⁶ Few other details about that particular performance are known, but the group gave its second performance just a few weeks later, on April 11, 1932, this time at the Arts and Letters Club. Their extremely varied program included viol consorts by William Byrd, chamber music in various orchestrations by Leonardo Vinci, Jean Baptiste Loeillet, solo harpsichord music by Handel, Mozart, Couperin, and Bach, and music for viola da gamba with harpsichord by Bach, Couperin, Lully and Francoeur.⁵⁷ Elie Spivak played treble viol, Leo Smith the bass viol, Harold Sumberg took the alto parts, and Donald Heins the tenor lines.⁵⁸

The Conservatory String Quartet players are said to have been very taken with the viols, and records of their performances on them are chronicled for a full two decades, through the 1951–52 season.⁵⁹ Donald Heins was replaced in 1934 by Tim Brennand, who in turn was replaced in 1937 by Cecil Figelski. Elie Spivak and Leo Smith were the most keen and active,⁶⁰ but members of the ensemble performed on the viols at least once every season. In addition to regular appearances on the afternoon and evening concert series at Hart House, documents indicate that Arthur Lismer asked the group to perform at the Art Gallery of Toronto (now Art Gallery of Ontario),⁶¹ and that they played with Healey Willan’s

⁵⁶ Hart House Music Committee minutes of February 10, 1932 confirm this performance and the details described.

⁵⁷ No other programs or repertoire from the Conservatory String Quartet are known.

⁵⁸ Hart House Viols File: Includes an April 6, 1932 announcement from the Arts and Letters Club about the upcoming performance, as well as the Arts and Letters Club concert program for April 11, 1932.

⁵⁹ Hart House Music Committee minutes document their regular use, concluding with the 1950–51 Annual Report that reads: “The viols are reported to have been borrowed by Leo Smith and Elie Spivak on numerous occasions this season.” The 1951–52 Annual Report says, “An instrument borrowed by Elie Spivak has been returned, one of its strings having been replaced.” The conclusion of the Conservatory Quartet members’ use of the viols seems to coincide with Leo Smith’s death, on April 18, 1952.

⁶⁰ See Appendix 2 for more complete biographical information about Elie Spivak and Leo Smith.

⁶¹ Hart House Music Committee minutes of November 14, 1935.



Elie Spivak, late 1940s.

(Photo by Richard Morawetz, courtesy of www.oskarmorawetz.com)

Tudor Singers at the Church of St. Mary Magdalene,⁶² were featured on CBC Radio broadcasts in 1938 and 1948,⁶³ and also gave a variety of performances in conjunction with classes at the University of Toronto.⁶⁴ Over the years, Leo Smith composed a number of pieces that incorporate viols. These include settings of Shakespearean songs for voices with bass viol, some arrangements of thirteenth-century responsories, *Lullaby* (based on a Byrd melody) for voices and viols, a transcription of William Cornysh's *Adieu my heart's desire* for voice, bass viol and harpsichord, variations on *The Carman's Whistle* for four viols, *Pavane* for treble and bass viols with harpsichord, and arrangements of Elizabethan

⁶² Hart House Music Committee minutes of February 11, 1937.

⁶³ Hart House Music Committee minutes of January 17, 1938 and November 22, 1948. The second of these broadcasts is confirmed by CBC Radio archives, which attests to broadcasts on October 6 and 13, 1948 (recorded on October 2, 1948).

⁶⁴ Hart House Music Committee minutes.

tunes for various combinations of viols and harpsichord.⁶⁵ Smith was especially enamored of the bass viol; he borrowed it on numerous occasions even when not performing with the consort. According to his official biographer,

Smith would sometimes take it home at night and keep it in a bedroom of its own, with curtains drawn to prevent drafts and a very light eiderdown plus a Shetland shawl ready for changes of temperature and humidity. I speak with authority here because I was more than once asked to “babysit” that gamba when the Leo Smiths were away, warned to rush out first with the gamba in case of fire.⁶⁶

The tussle between the Arts and Letters Club and Hart House about ownership eventually reached its conclusion, but not without a final bit of drama. Several years had passed with the two establishments regularly squabbling about who would pay insurance and maintenance costs and whether various repairs and supplies were reasonable or necessary.⁶⁷ In the spring of 1935, the Club needed to raise money and grudgingly offered to allow Hart House to purchase its share for the original investors’ amount of \$800.⁶⁸ This seemingly modest sum was, however, not so easy for Hart House to raise during the Great Depression, and it was only able to do so a day or two before the final deadline, after Warden Bickersteth wrote an impassioned and embarrassed plea to Vincent’s wife Alice Massey, begging a special grant or loan from the Massey Foundation.⁶⁹ She honored his request,⁷⁰ and on September 30, 1935 a full transfer of ownership to Hart House was offi-

⁶⁵ Pearl McCarthy, *Leo Smith: A Biographical Sketch* (Toronto: University of Toronto Press, 1956), 49–50.

⁶⁶ *Ibid.*, 27.

⁶⁷ The complete correspondence is contained in UofT 082(01).

⁶⁸ Arts and Letters Club Executive Committee minutes of April 30, 1935 read: “An offer from Warden Bickersteth of \$800 for the Club’s interest in the viols was received with sniffs but it was subsequently decided to accept.”

⁶⁹ UofT 082(01): Letter of September 25, 1935 from J. Burgon Bickersteth to Alice Massey.

⁷⁰ University of Toronto Archives, Vincent Massey Personal Records, B1987-0082/080(09). Receipt dated only September 1935 indicating that the Massey Foundation issued an \$800 check to the Arts and Letters Club for the purchase of the viols.

cial.⁷¹ Not wanting to create more discord between the Massey family and the Arts and Letters Club, this source of funding has always been kept quiet. The truth is that when all was said and done, the Massey Foundation had underwritten the entire cost of the original purchase, and eight prominent Toronto society members had also each invested \$100 (the latter benefiting the Arts and Letters Club). This proved a sound investment, however, since the collection today can truly be said to be priceless. Financial valuation aside, it is no exaggeration to say that the instruments are irreplaceable antiques and that, as it turned out, they have been a tremendously important and influential part of Canada's viol-playing heritage. Their presence and use can be credited for having helped instigate and engender a genuine love and appreciation for viols and early music in Toronto, long before other local early music institutions came on the scene. There has since been an abundance of viol activity in the area, and indeed some renowned players currently active in North America got their start in Toronto.

Over the years since the Conservatory String Quartet, the Hart House viols have continued in fairly regular use. From the fall of 1952 through the 1969 season, Wolfgang Grunsky (1902–91) spearheaded most of the activities on them. Grunsky was a cellist in the Toronto Symphony Orchestra (1954–72), but he originally came to Toronto from Austria in 1951 to teach Renaissance and Baroque music on viols and recorders at the University of Toronto and the Royal Conservatory of Music.⁷² In October 1952, Grunsky formally received permission to use the Hart House viols, and the chest was moved to the Royal Conservatory so that he would have ready access to it.⁷³ Over the next seventeen years, Grunsky orga-

⁷¹ Arts and Letters Club Executive Committee minutes of October 9, 1935 read: "The President read a letter from Bickersteth of Hart House to R. L. Defries acknowledging a cheque for \$800 in payment of the Club's interest in the Hart House viols...resolved that the action of the Treasurer [Defries] accepting this offer be confirmed."

⁷² For a more detailed biography of Wolfgang Grunsky, see Appendix 2. I am grateful to Michael Grunsky for sharing family memorabilia and many details about his father's life and career.

⁷³ Appendix to Hart House Music Committee minutes of October 28, 1952. At this time the collection was insured for \$4,500.

nized numerous concerts using the instruments;⁷⁴ his most frequent colleagues on viols were Joyce Gundy, Doreen Hall, Eileen Bordessa, Maria Grunsky (his wife), Klemi Hambourg, Berul Sugarman, Macey Cadesky, and William Kuinka. Grunsky's ensemble took many forms and played under many names, but by the early 1960s they mostly performed as the Toronto Renaissance Quintet. The ensemble was frequently augmented by collaborators, including recorder players Hugh Orr and Joyce Gundy, singers Ingrid Fistell (who also played treble viol and lute), Isabelita Alonso, Lois Marshall, and Elizabeth Benson Guy, harpsichordists Greta Kraus and Douglas Bodle, and lutenist Hans Kohlund. In the summers of 1954 to 1957, the Quintet performed as part of the Shakespeare Festival at Trinity College. On a CBC-TV broadcast "Music in Miniature" on March 9, 1961, Grunsky performed music by Giovanni Coprario with Hans Kohlund. Other records reveal that the full ensemble gave CBC Radio broadcasts in 1953 and 1964. The ensemble played regularly at Hart House and was profiled in a number of magazine and newspapers articles. Hart House Music Committee records document much enthusiasm and support for the Toronto Renaissance Quintet's activities, even to the extent of helping the ensemble obtain funding for external concert opportunities.⁷⁵

From the mid-1960s the viols were used at the University of Toronto, both by graduate music students and by members of University of Toronto's Centre for Medieval Studies, particularly by students in the *Poculi Ludique Societas*. Beginning in 1964, PLS sponsored productions of early plays ranging from the beginnings of medieval drama to the middle of the seventeenth century. Bruce Bellingham, former President of the Viola da Gamba Society of America, and Elizabeth Ganiatsos, Artistic Director of the Thunder Bay consortium *Aurora Borealis*, have shared many fond reminiscences about their student days in Toronto and use of the viols, which to a great extent influenced their lifetime passion for the viol and its music. According to Ganiatsos, music professor Harvey Olnick had a requirement that all University of Toronto

⁷⁴ See Appendix 3 for a complete list and details of Grunsky's performances on the Hart House viols.

⁷⁵ Hart House Music Committee minutes.



Toronto Renaissance Quintet with the Hart House viols
(l-r, William Kuinka, Ingrid Fistell, Macey Cadesky, Joyce Gundy,
Wolfgang Grunsky).

(Photo courtesy of Thomas G. MacCracken, from the Viol List file)⁷⁶

musicology students participate in the early music ensemble *Hortus Musicus*, which met every Monday night in the Bickersteth Room on the top floor of Hart House. This was

a time when women were not [yet] allowed into Hart House. We would climb the stairs to the top, and pass through a door, which gave on to a red-carpeted hallway, in the private guest rooms section. Halfway down the hall stood the carved chest of viols. ... We would lovingly lift up our own instrument and proceed to the Bickersteth Room ... where we would read through a variety of consort music. At that point in time the viols did not leave the building, not even the 3rd floor. However, I was involved for the PLS (back in the days when Middle English was still used in all productions) and we performed two 15th-century mystery plays from the Towneley Cycle, for the Ontario Music Educator Association's annual convention, in 1968. The musicians were in costume for this production, representing animals from Noah's Ark.

⁷⁶ The Viol List, Thomas G. MacCracken's database of all extant viols made before the twentieth century, continues the work of Peter Tourin's *Viollist* (Duxbury, VT: The Tourin Musica, 1979).

Bruce [Bellingham] was a raven, all in black, with scalloped felt coming down below the neck, etc. and I was a dove; we wore *papier-mâché* animal heads.⁷⁷

Among the many other people who had contact with the viols during that epoch were Donald Whitten, Donald Warnock, Murray and Elizabeth Robb, David Klausner, John Sawyer, and Roxanna Kinahan.

In recent years, the name most frequently associated with the Hart House viols is Peggie Sampson (1912–2004).⁷⁸ The foremost viola da gamba player in Canada's history, she was for many decades much sought as a teacher and recitalist. Sampson immigrated to Canada from Scotland in 1951, initially to teach theory, history, and cello at the University of Manitoba, but in 1960 she developed a passion for the viola da gamba, and by the end of that decade the viol had eclipsed her interest in the cello. In 1970 she moved to Toronto to take up a position at York University, where she taught theory and developed a program for viols. Her first association with the Hart House viols dates to September 12, 1972, when she wrote to the Warden Jean Lengelle, requesting that her consort from York University be permitted access to them on a regular basis.⁷⁹ Permission was granted, and a first performance took place almost two years later on November 10, 1974 on Hart House's Sunday Evening Concert series, under the name "The York Consort of Viols."⁸⁰ The ensemble comprised Peggie Sampson, Christel Thielmann, Rosamund Morley, Murray Charters, and Alison Mackay on viols, plus soprano Henriette Asch, baritone Jon Higgins, and harpsichordist Michael Kearns.

Sampson's consort was extremely active for the following two and a half years, through May 1977. For the first few months they performed mostly without a moniker, listed under the direction of Peggie Sampson. The name "The Hart House Consort of Viols"

⁷⁷ E-mail correspondence of April 9, 2009.

⁷⁸ For a more detailed biography of Peggie Sampson, see Appendix 2.

⁷⁹ A copy of Lengelle's reply to Sampson's letter was located in the chest, April 2009.

⁸⁰ I am very grateful to Alison Mackay, whose thorough documentation of the Consort's activities makes it possible to detail the instruments' use. I have found no other sources for this information, save word of mouth.



The Hart House Consort of Viols, c.1976
(l-r: David Hirschorn, Alison Mackay, Gregor Brown,
Rosamund Morley, Peggie Sampson, Murray Charters).
(Photo courtesy of Alison Mackay)

was used for the first time at the group's only U.S. appearance, a performance at the American Musicological Society meeting in Buffalo, New York on October 4, 1975. The ensemble gave at least twenty performances in and around Toronto but also traveled elsewhere in Ontario. Murray Charters was responsible for many of the administrative duties. The ensemble expanded and contracted, most often including viol players Gregor Brown and David Hirschorn, but also with Pat Hanley, Brian Franklin, and Eugene Stecky on occasion. Performances usually included voices, plucked instruments, and/or keyboards, and the programs centered primarily on music of the sixteenth and seventeenth centuries.⁸¹

⁸¹ See Appendix 3 for a complete list of the Consort's performances and personnel.

In addition to performing old music, Sampson was herself also a champion of new music and she used the Hart House instruments, especially the bass viol, for her own projects through the early 1980s.⁸² During the years she was associated with the Hart House viols, she commissioned and premiered works by Bernard Naylor (*On Hearing Mrs. Arabella Hunt Singing*, 1970), Murray Adaskin (*Adagio and Allegretto*, 1972), David Rosenboom (*The Seduction of Sapientia*, 1975) and Rudolph Komorous (*At Your Memory the Transparent Tears Fall like Molten Lead*, 1976). The Hart House bass viol was until very recently set up with a bridge dated June 24, 1976 made by Dietrich Kessler, who was at that time working for H. Withers in London.⁸³ It may be logically assumed that Sampson herself traveled to London to have this made; Hart House itself has no records of the work being done.

The Instruments

By the early 1970s Hart House started to become conscious of the value and rarity of the viols in their collection. Until that time the instruments were a pleasant novelty, appreciated mostly by players and academics, but no one at Hart House really had a sense of what they were or their value, individually or collectively. The only appraisal on file was that written by Auguste Delivet in 1926 for Vincent Massey,⁸⁴ in which the viols were described in very loose and imprecise terms. Of course, in the 1920s viols were a rarity and the subject had not been much studied or documented. It is therefore hardly surprising that Delivet was out of his depth making attributions for makers of instruments that bear few reliable identifying marks. His appraisal assigned the name Louis Guersan to a small 5-string instrument in the collection, since it was clearly labeled. A second small instrument was correctly, if imprecisely,

⁸² Hart House Music Committee minutes document that Sampson's final request to use the viols was February 5, 1982, but this was denied at a March 5, 1982 meeting, because "timing is poor for student attendance."

⁸³ The bridge is now located in the chest, but was on the viol and in use up until the fall of 2008 when it was removed and replaced by William Monical.

⁸⁴ UofT 082(01): Untitled appraisal of the six viols, in French, precise date unknown but fall 1926 at the latest, since this document was said to be sent to Lotta van Buren by Vincent Massey with his letter of January 7, 1927.



“Canada’s Foremost Viola da Gambist, Peggie Sampson, during a Television Appearance for the Canadian Broadcasting Corporation, Toronto” [with Hart House’s Tielke bass].

(Photo by Walter Curtin, date unknown; © National Gallery of Canada⁸⁵)

identified as “old French,” and the other four instruments were erroneously described as being of Italian make: two of Venetian provenance, another “ancient Italian,” and the fourth by Carlo Bergonzi. Aside from these descriptions there were no other names or dates, let alone “sizes” or “types” to put with them. For

⁸⁵ Canadian Museum of Contemporary Photography, Ottawa, Accession # EX-82-401.

Hart House and players of the viols, it was challenging to know how to describe the instruments short of saying the viols were all very old and each had a visually stunning carved head! As a result the collection was little known outside of the Toronto area. However, some word of mouth, at least among players, must have taken place. In 1971, Günther Hellwig visited Toronto and authenticated the largest instrument in the Hart House collection as being a bass viol by the Hamburg luthier Joachim Tielke, c.1699.⁸⁶

In mid-January 1974, at Peggie Sampson's invitation and expense, William Monical of Staten Island, New York came to Toronto and spent a weekend in the Bickersteth Room at Hart House appraising the viols.⁸⁷ This was the first time since their arrival in Toronto that all six of the viols were studied and assessed by a viol expert. Monical's report detailed the two smallest instruments as pardessus, one the five-string instrument by Guersan (1761), the other a six-string instrument by Nicolas Bertrand (c.1710).

It wasn't until quite recently, however, that attributions could be made for the remaining instruments. During the summer of 2008 the bass viol by Tielke was again viewed and authenticated, this time by Friedemann Hellwig.⁸⁸ In March 2009 Benjamin Hebbert, an expert on English viol makers, was engaged by Hart House and spent a week in Toronto assessing the collection.⁸⁹ In addition to the two pardessus and Tielke bass, the Hart House collection includes a treble viol (possibly yet another pardessus) believed to be French, likely non-Parisian, dating to the second half of the eighteenth century. The two remaining viols are English and the most interesting of the collection, by virtue of the relative scar-

⁸⁶ Günther Hellwig, *Joachim Tielke: Ein Hamburger Lauten- und Violenmacher der Barockzeit* (Frankfurt am Main: Verlag das Musikinstrument, 1980), 259.

⁸⁷ For this information, I am grateful to Rosamund Morley. Monical's appraisal is dated February 2, 1974, and is part of the Hart House Viols File.

⁸⁸ I am grateful to Prof. Friedemann Hellwig for sharing his full assessment with me in e-mails of December 17, 2008 and August 5, 2009. Prof. Hellwig is a distinguished conservator of old instruments, who is currently engaged in preparing a second edition of his father's book on Tielke.

⁸⁹ Hebbert's appraisal is dated May 24, 2009 and is part of the Hart House Viols File.

city of other surviving instruments by their renowned makers, and since they retain many of their original features and details. They are a small English treble viol made by Henry Jaye of Southwark, c.1615–20, and a large English treble viol by John Rose, Jr. of Bridewell Palace, c.1590s.⁹⁰ The Jaye has a body length of 33 cm and is original except that it bears a late-nineteenth-century English head. The Rose has a body length of 42.5 cm and is currently tuned as a tenor viol. It is essentially original, except that it was at one time adapted to be held under the chin, but it bears a label indicating that in 1899 it was restored to its viol shape. Somewhat enigmatically, all six viols are stamped with the number “1231” next to the hookbar. It is not known who made those stamps, nor when; the style and location do not correspond with stamps from any known dealers or instrument exhibitions.⁹¹

Hart House additionally owns three interesting old bows. One is a fluted English violin bow, c.1700, that bears a similarity to the Walmsley violin bow, c.1720, at the Ashmolean Museum, Oxford. A second bow is a transitional French violin stick, c.1800, and a third is a fluted French viol bow, c.1740.

The name George St. George is associated with several of the Hart House instruments. Best known as a performer on the violin and viola d'amore, St. George was born in Leipzig in 1841, studied in Dresden and Prague, and settled in London in 1862. His son Henry was an expert on string instruments, serving as Editor of *The Strad* magazine for several years and authoring a book on the

⁹⁰ English treble viols of this period were built in a variety of sizes. The Hart House Jaye and Rose viols represent two different sizes, but both can be described according to this terminology, representing opposite ends of the scale. In order to clarify that there is a 9.5 cm difference in body length between the two, I have therefore chosen to distinguish between them by calling one a “small English treble” and the other a “large English treble.” Large English trebles are sometimes confused with tenors, or misleadingly labeled “alto viols.” Real English tenors of this period, however, including two by Rose himself, are significantly larger than the Hart House instrument, and it is for this reason that the Hart House Rose viol is being designated a large English “treble.”

⁹¹ Detailed descriptions and specifications of the viols are included in Appendix 1.

bow.⁹² Father and son are pictured in a photograph, with Henry holding a bass viol.⁹³ One wonders if George St. George perhaps had a small side business dealing in and repairing ancient instruments, and if he was Head's source for the Hart House collection. Unfortunately, no documents are currently known to support or deny such speculation. What does seem certain is that the Hart House instruments did not come via the William Hill and Sons shop (1880–1992),⁹⁴ nor do any of them match items documented in Canon Francis W. Galpin's personal collection.⁹⁵ It is also unlikely that Arnold Dolmetsch would have owned them prior to Head's move to Canada in 1910, only to request copious details about them in 1928.⁹⁶ The Hart House Rose treble viol bears the most extensive restoration by St. George, but the Bertrand pardessus and the Jaye treble also have labels indicating his work.⁹⁷ An old pardessus bridge and the head on the Jaye treble are

⁹² Henry St. George, *The Bow, Its History, Manufacture and Use* (London: The Strad, 1909).

⁹³ This instrument is possibly the Barak Norman bass restored by George St. George in 1890, now in private ownership in Spain. I am grateful to John Pringle and Thomas G. MacCracken for their assistance identifying this instrument.

⁹⁴ It is impossible to authoritatively trace all of the instruments that went through the Hill workshop over the years, since most of the business records were dispersed and/or destroyed in 1992. However, the Hart House viols were stamped as a collection (the same number on six instruments) at the hookbar on each instrument, and these stamps do not match the location (ends of fingerboards) or typography used by the Hills. With the additional indications of restoration work by George St. George and Joseph Chanot, the likelihood that the viols were sold/acquired through the Hill shop diminishes even more.

⁹⁵ Galpin's collection of viols was impressive, yet none of Head's viols can be said to have originated there, in spite of the fact that the two men were on friendly terms. Most of Galpin's viols are now located at the Museum of Fine Arts, Boston.

⁹⁶ The Dolmetsch Foundation was established in 1928. Arnold Dolmetsch and his family were active as viol players before that time, but from 1905 to 1910 Arnold worked at the Chickering Factory in Boston. Chickering made pianos, but while working there, Dolmetsch made harpsichords and clavichords. I am grateful to Dr. Brian Blood for consulting what archival materials exist for the Dolmetsch Foundation; he was unable to find any records pertaining to W. Howard Head.

⁹⁷ Three photos of St. George's finished restoration and a photo of a drawing for the restoration of the back of the pegbox of the Hart House Rose viol exist,



George and Henry St. George, c.1889.
(Photo courtesy of and property of Joseph Peknik III, NYC)

additionally very likely by his hand. In each case, the workmanship is absolutely stunning. Given his evident skill at restoration, it is surprising his name is only known nowadays through isolated examples.⁹⁸ Perhaps the Hart House collection will spur more research to determine the extent of his activities.

and would seem to date to a period prior to the viol's arrival in Canada. I am grateful to John Pringle for calling my attention to and providing me with these photos, which he obtained from Michael Heale.

⁹⁸ Joseph Peknik called my attention to St. George's work on at least one Barak Norman bass viol at the Metropolitan Museum of Art in New York, and

In light of the information that Hart House received about the viols, beginning in late 1973, discussions were initiated to address what needed to be done to safeguard and conserve the collection. From the late 1970s through the 1990s, numerous discussions took place at Hart House concerning the future of the collection, debating the pros and cons of having the viols professionally restored (and if so, who would do this work), trying to ascertain if the viols would be better off turned over to a professional organization such as the Canada Council Instrument Bank to monitor who used them, or even if the collection would be better “conserved” in a museum-quality setting.⁹⁹ The complexity of these issues resulted in lengthy discussions and a long-delayed decision. In January 1993, Robert Barclay, Senior Conservator of the Canadian Conservation Institute in Ottawa, visited Hart House to assess the condition of the viols and to offer advice concerning various options for conservation. Barclay claimed three options were available: a) to leave the instruments in their present, little-used state and little-known location; b) to insure they were in good health and playable condition and use them in concert; or c) to conserve and display them in Hart House. It was the latter option that Barclay favored.¹⁰⁰

Thomas MacCracken mentioned his work on a Nicolas Bertrand bass viol owned by Laurence Dreyfus. There are also several instruments made by George St. George, including the “Dolphin-head” bass viol that bears an inscription indicating it was made in 1895 for his son Henry (privately owned in New York), a viola d’amore with a square head and carved “eyeball” (owned by the Society of Ancient Instruments in Philadelphia), and a viola d’amore with a self-portrait for a head (current location unknown to me) that is illustrated in Harry Danks, *The Viola d’Amore* (Halesowen: Bois de Boulogne, 1976), plate 14, located between pp. 48 and 49.

⁹⁹Hart House Music Committee minutes and Hart House Viols File. Documents include several in-house reports summarizing what little information was currently to hand about the viols and their provenance: “Summary” by A. Hozack in 1974, “Report on the Viols” by Brian Pronger in 1981, “Appraisal” by Michael Remenyi in 1982, correspondence with Canada Council Instrument Bank in 1991, Robert Barclay’s “Report and Recommendation of 1993,” “Insurance Appraisal” by Christie’s, NY, in 1997, and “Installation Project Proposal” by Lisa Mackay in 1998.

¹⁰⁰Hart House Viols File: Robert Barclay, “Canadian Conservation Institute: Recommendations for the Hart House Viols,” February 1993, p. 16.

The decision having been made to move forward with conservation, in 1995 plans were drawn up for a special humidity-controlled display case to be built and installed in the Gallery Lounge, the antechamber to the Gallery Grill on the second floor of Hart House.¹⁰¹ This would allow the instruments to be seen on a day-to-day basis, while safeguarding them from the deleterious effects of the environment. At the same time, Hart House did not abandon the idea of allowing the instruments to be played in the future. A 1996 letter to the designer of the display case from the Warden, Peter Turner, explained,

The purpose of the display is to be in keeping with Hart House's mission which emphasizes experimental and informal learning—in music for example—and also emphasizes fellowship. Therefore the display should account for some educative communications. In the long term, it is our hope that the viols will not only be displayed, but played once again. . . . This bears on accessibility. By the same token, the viols must be fully secured.¹⁰²

The viols were placed into their case in fully functional playing condition. A ceremony unveiling the new display took place at the Gallery Grill on May 30, 1999.

In keeping with Hart House's interest in allowing the instruments to be used in performance from time to time, the viols have come out of the display case several times since then. I, myself a viol specialist who returned to my hometown of Toronto in the fall of 2004, have been responsible for much of their recent study, documentation, and return to use. Viols have been borrowed on three occasions for viol consort programs on my Scaramella series, held at Victoria College Chapel and repeated at Hart House.¹⁰³ In No-

¹⁰¹ Hart House Viols File: Letter of April 27, 1995 from Robert Barclay to the Hart House Music Committee with recommendations about various specifications for the display case.

¹⁰² Hart House Viols File: Letter of March 26, 1996 from Peter F. Turner to Norman McMurrich, Consultant, NORR Partnership Ltd., in charge of designing the display case.

¹⁰³ A concert on December 8, 2005 entitled "Viols n' Femmes" featured Joëlle Morton, Liam Byrne, Annalisa Pappano, Joanna Blendulf, and Julie Jeffrey. A concert on March 15, 2008 entitled "Musica Instrumentalis: Variations and Enigmas" featured Joëlle Morton, Justin Haynes, Sheila Smyth, Katherine Hill, and Kate Bennett-Haynes; viol music by Leo Smith was included. Most recently, the Tielke bass was utilized for Scaramella's "Bach Extravaganza" concert on

ember 2009 I was officially hired by Hart House to serve as their Viol Consultant, overseeing the administration, health, housing, use, and publicity for the collection. Since then, a website about the collection has been created (www.harthouse.ca/viol), an article has appeared in *Hart Beat* magazine, formal policies about future use and processing of applications have been set, and updated descriptions for the display case have been installed. As of January 2010, my students in the viol consort at the University of Toronto Faculty of Music have been rehearsing each week at the Gallery Grill, using the instruments. Our meetings are “open door sessions” so that members of the public may drop in to hear the viols played and learn about their history and use.

In recent years, the viols were also utilized by the Hart’s Ease Consort at the Gallery Grill on February 9, 2006, where I was joined by three accomplished Toronto amateur players: Shaunie Young, Sara Blake, and Linda Deshman. Les Voix humaines of Montreal used the viols for a recording of Henry Purcell’s viol fantasias, released April 2009 on the ATMA label.¹⁰⁴ For that project, the six viols were taken to Staten Island, New York and worked on by William Monical. Each instrument received a new bridge, sound post, and strings, and any cosmetic details not deemed perfect were touched up. The instruments received unusual set-ups: the Rose was tuned as an alto (in A), the Jaye treble was played as a pardessus, and the Tielke bass was strung as a tenor (in G). Les Voix humaines repeated the program live on June 25, 2009 at the Montreal Baroque Festival, and on October 30 and 31, 2009 in Toronto as part of the Toronto Consort series.

When Vincent Massey invested in Roy Mitchell’s scheme to bring the chest of viols to Toronto in 1919, he had little idea of the genuine value and merits of the particular instruments in the collection, yet he clearly believed in the investment for nationalistic and philanthropic reasons. Just 32 years old and a long way from

February 13, 2010, and previewed at Hart House for a Breakfast With the Bulletin event on February 10, 2010.

¹⁰⁴ACD2 2591. The ensemble comprises Susie Napper, Margaret Little, Mélisande Corriveau, Elin Söderström, Arnaud Leroy, Marie-Laurence Primeau, and Felix Deak.

achieving the status for which he is most renowned today, he had little musical training himself; certainly he did not play viol, nor purchase the viols with the intent to learn to play them. Rather, he seems to have viewed the chest as an investment in Canadian cultural heritage. In a 1932 letter to Sir Ernest MacMillan, Massey said,

The Massey Foundation came into the picture originally for the purpose of keeping the viols in Canada and making them available for Canadian musicians. That was [our] only motive. We are very glad indeed that the viols are now finally in use.¹⁰⁵

In Massey's eyes, the chest of viols must have represented the perfect kind of accouterment with which to stock the Music Room at Hart House. The instruments were certain to intrigue and inspire an appreciation of music, and they bore immediate relevance to literature, drama, and history. In addition they offered a stimulating and satisfying pastime. Massey's investment in the Hart House viols is truly a gift to Canada, and one that he would have been thrilled to know has fostered so much interest and passion among Canadian musicians and audiences. This national treasure is one to be cherished for its own sake, as much as to celebrate the spirit in which it was given.

¹⁰⁵ Letter of April 11, 1932 from Vincent Massey to Ernest MacMillan.

Appendix 1: Descriptions of the Instruments

Descriptions and notes on the instruments are compiled, condensed, and summarized from written documents provided for Hart House by:

William L. Monical (Insurance Valuation, Feb. 2, 1974).

Brian Pronger (Notes on the Collection of Viols, researched prior to May 1981).

Michael Remenyi (Insurance Appraisal by the Remenyi House of Music, Toronto, Dec. 9, 1982).

Robert Barclay (Recommendations for the Hart House Viols, Feb. 10, 1993).

Thomas G. MacCracken (The Viol List, accessed January 13, 2006).¹⁰⁶

Benjamin Hebbert (Valuation and Identification of Musical Instruments Belonging to Hart House, May 24, 2009).

Friedemann Hellwig (personal correspondence with Joëlle Morton, Aug. 5, 2009).

The verbal descriptions below are based on Remenyi's 1982 appraisal unless otherwise noted.

Measurements (in cm) were documented by William Monical (1974), except for the rib depths, which are documented in The Viol List (2006).

Photos of the bodies of the Hart House viols are by Michel Mercereau. Photos of the heads of the viols, the stamp, the chest, and the bows are by Joëlle Morton.

¹⁰⁶ Thomas G. MacCracken informs me that for the purposes of the Viol List, the Hart House viols were first documented in a letter of January 25, 1964 by Wolfgang Grunsky to Gian Lyman. The viol descriptions were subsequently updated by Peter Tourin, seemingly after an inspection by Donald Warnock (the date of whose visit to Toronto is unknown).

Pardessus, Louis Guersan, Paris, 1761

Label: "Ludovicus Guersan prope comoediam Gallicam lutetiae
anno 1761"

Body length: 32.8

Neck length: 13.15

Body widths:

String length: 31.2

Upper bout: 16.1

Rib depth: 5.6

Center bout: 11.35

Mensure: 17.1

Lower bout: 19.6





Description: The back and ribs are formed from quarter sawn maple strips alternating with fruitwood (pear or cherry) strips. The maple shows narrow horizontal flames. The back has double purfling. The table is of two pieces of spruce showing fine grain at the center opening somewhat toward the flanks. The table is double purfled. The maple neck terminates in a carved maiden's head. The pegbox is embellished with floral carving and beading. The pegs, fingerboard, and tailpiece are of ebony and chased with ivory and bone trim. Varnish is a golden orange color.

Notes: The instrument is original in all aspects (neck, pegs, and bass bar included) except bridge, soundpost, tailpiece, and fingerboard. The ribs and back with their stripes are characteristic of other instruments from this maker.¹⁰⁷ The head is not "*La fille*" type.¹⁰⁸

¹⁰⁷Pronger, p. 1.

¹⁰⁸The Viol List.

Pardessus, Nicolas Bertrand, Paris, c.1710

Label: “B__ND” faintly stamped on button

Body length: 31.3

Neck length: 14.3

Body widths:

String length: 30.8

Upper bout: 15.7

Rib depth: 7.0

Center bout: 11.25

Mensure: 16.5

Lower bout: 18.7





Description: The back is unpurfling and formed from two pieces of maple showing medium wide flames slightly ascending from center. Ribs are of matching maple. The table is of spruce showing fine, even grain and has single purfling. The neck is original, but somewhat thinned. The pegbox is elaborately carved and terminates in a maiden's head. Pegs are rosewood. The fingerboard and modern tailpiece are ebony. Varnish is a deep red-brown color on orange ground.

Notes: The instrument shows much worm damage and numerous cracks, which have all been repaired. A repair label reads: “Restored by G. Saint-George, London, 1899.” Also thought to be by St. George are the bass bar and a bridge (no longer on the instrument). The neck and fingerboard are believed to be original.¹⁰⁹ The instrument has overhanging edges.

¹⁰⁹ Pronger, p. 2.

Pardessus or Treble viol, maker unknown, thought to be second half of 18th century, French (possibly François Lupot)¹¹⁰

Label: none

Body length: 34.5

Neck length: 20.5

Body widths:

String length: 39.5

Upper bout: 17.2

Rib depth: 8.6

Center bout: 12.4

Mensure: 18.2

Lower bout: 20.2



¹¹⁰ Attribution by Hebbert.



Description: The back has no purfling and is formed from two pieces of maple showing medium wide flames slightly ascending from center. Ribs, neck, and head are of plainer maple. The table is of pine, showing varied, mainly medium wide grain. The table is highly arched with single purfling. The pegbox terminates in a stylized lion's head. The fingerboard and tailpiece are of ebony. Varnish is a golden orange color.

Notes: All aspects of this instrument appear to be original, except for the bridge and soundpost. The neck is vastly wider than

normal for an instrument of this size. There is evidence of some restoration on this instrument, which took place before its arrival in Toronto. The table arching has been reshaped and a breast patch fitted, an area of the center join on the back has been reinforced and filled, shrinkage cracks on the ribs have been repaired.¹¹¹

According to Hebbert, "The large neck is unusual and suggests it was made outside of the dominant pardessus-making schools. Moreover, the poor quality of the carved head firmly excludes Paris as a place of manufacture, since the division of guilds in the late 18th century both prohibited instrument makers from carving, and ensured that all carving was carried out by professional carvers. The instrument is clearly made by a competent professional violin maker, who was unaccustomed to the viol-making tradition, and the varnish is typical for Parisian work and other French workmanship that took Paris as its influence. François Lupot working in Orléans represents such an instrument-maker. Regrettably, we have no further basis upon which to attribute the instrument to this, or any other maker."¹¹²

¹¹¹ Pronger, p. 3.

¹¹² Hebbert, p. 2.

**Small English treble viol, attributed to Henry Jaye,
Southwark, c.1615–20¹¹³**

Label: “1734 Carlo Bergonzi fecit Cremonae” [fake]

Body length: 33.0

Neck length: 15.1

Body widths:

String length: 33.3

Upper bout: 15.8

Rib depth: 8.0

Center bout: 11.05

Mensure: 17.5



¹¹³ Size terminology by Morton, attribution by Benjamin Hebbert, 2009.



Description: The back is one piece, double purfled, formed from sycamore showing faint mottled figure. Ribs, also double purfled, are of matching sycamore. The five-piece table has a low arch and is of spruce showing varied fine to medium wide grain. The plain pegbox terminates in a man's head bearing a laurel wreath, but the head is much newer than the rest of the instrument. The fingerboard and tailpiece are veneered ebony. Varnish is a rich orange-brown color on golden ground.

Notes: Carved head is late nineteenth century (possibly George St. George), but the neck is thought to be original. The table has suffered considerable worm damage. Shrinkage cracks abound on ribs and back. The instrument has been over-varnished, on the table in particular.¹¹⁴

¹¹⁴Pronger, p. 3.

**Large English treble viol (tuned as an alto or tenor viol),
attributed to John Rose Jr., Bridewell Palace, c. 1590s¹¹⁵**

Label: none

Body length: 42.5

Neck length: 26.75 (outsized)

Body widths:

String length: 49.4

Upper bout: 20.55

Rib depth: 9.2

Center bout: 14.9

Mensure: 22.15

Lower bout: 25.0



¹¹⁵ Size terminology by Morton, attribution by Hebbert.



Description: The back is formed from two pieces of maple showing narrow irregular curls. Ribs are of maple showing broader figure, while the neck is modern and shows horizontal flames. The two-piece table is of spruce, has a low arch, and shows fine grain at the center, opening at the ribs. There is double purfling on the table, back, and ribs. Pegbox is covered with intricate floral carvings and purfling inlay design terminating at a bearded man's head crowned with a laurel wreath. Varnish is a golden orange-brown color on lighter ground.

Notes: Likely some time in the nineteenth century the rib depth was cut down, creating a fold in the lower bout, to permit this instrument to be played under the chin, like a viola. At the same time, the back of the pegbox casing was also modified, being cut/reduced into a traditional violin/viola form. These things were expertly reversed/restored by George St. George in 1899. A repair label reads: "Restored pegbox, ribs and back to their original form. Made fingerboard, tailpiece, bridge. G. Saint-George. London 1899." The neck is new, and unusually (disproportionately) long for the body size;¹¹⁶ the viol string length would more traditionally be approx. 42 cm. The hookbar is also likely by St. George.

¹¹⁶ Monical, p. 3.

Bass viol, attributed to Joachim Tielke, Hamburg, c.1699

Label: none

Body length: 66.2

Neck length: 29.8

Body widths:

String length: 64.1

Upper bout: 30.0

Rib depth: 12.7

Center bout: 22.6

Mensure: 33.2





Description: The arched two-piece back of maple shows medium wide horizontal flames.¹¹⁷ The maple beading at edges replaces what was likely originally ivory.¹¹⁸ Ribs are of matching maple.¹¹⁹ Table is not original,¹²⁰ but dates to a period prior to the

¹¹⁷ Remenyi, p. 3.

¹¹⁸ F. Hellwig.

¹¹⁹ Remenyi, p. 3.

¹²⁰ F. Hellwig.

viol's arrival in Toronto. It is made of two pieces (with added wings) of spruce showing medium grain at the center opening towards the flanks.¹²¹ The edging around the table is an alteration from the original, which was also likely ivory.¹²² The semi-open pegbox is covered in an elaborate floral carving terminating in a fine-quality woman's head with braided hair.¹²³ The rear of the pegbox is original, but the ribs and bottom part are not.¹²⁴ The foot of the neck and the neck itself, as well as the hookbar, are not original.¹²⁵ Fingerboard and tailpiece are modern, ebony veneer.¹²⁶ Varnish is a golden brown.¹²⁷

Notes: The head and pegbox are lovely examples of Tielke's work, and the attribution to Tielke and dating of the instrument are largely based on these things. The back is carved but does not have a medallion. The rest of the instrument is very plain, and was likely stripped of ornamentation (ivory edging) at a time prior to its arrival in Toronto. The instrument has numerous cracks that have been repaired, and there is evidence of worm erosion.¹²⁸ August Delivet's c.1926 appraisal implies that there used to be some indication that the instrument had been repaired and restored by Joseph Chanot in London.¹²⁹ No evidence of this is visible today, but the instrument perhaps arrived in Toronto with a bridge and/or tailpiece bearing Chanot's name, which has/have long since been replaced and discarded. Until the fall of 2008, the instrument was set up with a bridge made by Dietrich Kessler (at the time working for H. Withers, in London) dated June 24, 1976. Minor repairs and current bridge were done by William Monical in 2008.

¹²¹ Remenyi, p. 3.

¹²² F. Hellwig.

¹²³ Remenyi, p. 3.

¹²⁴ F. Hellwig.

¹²⁵ Ibid.

¹²⁶ Remenyi, p. 3.

¹²⁷ Ibid.

¹²⁸ Pronger, p. 4.

¹²⁹ UofT 082(01): Delivet's untitled appraisal of 1926 lists this instrument as "Viola de Gamba [*sic*]. Ecole de Venise. subie [*sic*] reparation et restauration partielle at [*sic*] parfait et remise en etat par Joseph Chanot de Londres."

The Stamped Number

All six viols are marked with the number “1231” stamped parallel to each instrument’s hookbar. It is not known who added these marks, or when; the style and location do not correspond with any known dealers or instrument exhibitions.

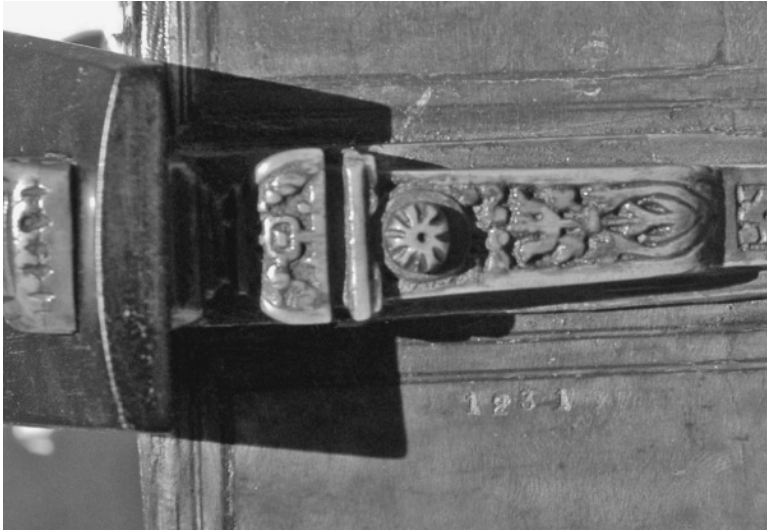

The Chest¹³⁰

Description: The chest is thought to be made of English brown oak (*Quercus robur*) with four inlaid panels of various as yet unidentified woods. It is heavily finished with a darkened varnish, although originally it was probably simply coated with linseed oil. The construction is mortise and tenon secured with wood pegs. A carved inscription reads: “MARGRET PLATTS 1673.” It is likely originally a dowry chest. The chest has been lined with sheets of zinc, which are covered with green plush velvet. There are two re-

¹³⁰Description and notes are based on Hart House Viols File: Robert Barclay, “Canadian Conservation Institute: Recommendations for the Hart House Viols,” February 1993, p. 4. Barclay identified the chest as being made of English brown oak, citing the species name *Quercus rubra*. This is clearly an error, however, since *Quercus rubra* is a North American species, whereas English brown oak is properly labeled *Quercus robur*.



movable trays (with brass fittings) custom-tailored to accommodate the six Hart House viols, stored on the bottom two layers, and their bows and accessories in a shallow top layer. The lid is lowered to close without any form of clasp or latch.

Notes: The chest is a historical object in and of itself, but has not to date been subject to much study. The lid is not original. It is also of brown oak, but is very smooth and flat, and has wood screws attaching the side moldings. The wrinkling of the zinc lining indicates shrinkage of the wood after installation of the metal; thus the wood was relatively fresh at the time it was fitted out for the viols. The lining of zinc, and all trays, fittings, and hardware, are recent adaptations. The folding lid props are wrongly installed: they fold downwards, causing the lid to fall unexpectedly.

The Bows¹³¹

At the time of the chest's arrival in Toronto, records indicate that it came equipped with bows for all of the instruments, although no descriptions of those sticks are available. There are currently seven bows at Hart House, but four of them are poor-quality modern German violin and viola bows. Only three sticks are old enough to have been part of the original collection. These are:

1. A fluted English violin bow, c.1700, snakewood, ivory frog, ivory button. Part of the tip has broken off, but the stick is still functional.

2. A fluted French viola da gamba bow, c.1740, swan head, snakewood, hardwood frog, ivory button.

3. A fluted transitional French violin bow, c.1800, pernambuco, ebony frog, ivory button.

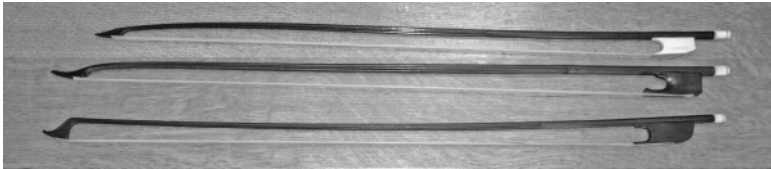

Hart House bows (top to bottom: English c.1700, French c.1740, French c.1800).

¹³¹ Datings are by Hebbert and descriptions by Monical.

**Appendix 2: Biographies of Key Figures
Associated with the Hart House Viols**
(ordered alphabetically)

Robert L. Defries¹³²

Robert “Bob” Defries (birth date unknown) was educated at Trinity College and Osgoode Hall Law School (both in Toronto) and went on to become a barrister specializing in corporate law for the firm of Cassels, Defries and DesBrisay. He was a founding member of and active with the Arts and Letters Club from 1908 until his death in 1957, and served as its Treasurer for almost 30 years, from 1909 to 1937. Defries donated to the Club a Lawren Harris painting, *Houses, Richmond Street*, the sale of which enabled the Club to purchase its current home at 14 Elm Street, Toronto, in the 1980s. Defries was also a member of the York Club and the Toronto Golf Club.

The Group of Seven¹³³

The Group of Seven was an organization of Canadian painters, founded in 1920 by Franklin Carmichael, Lawren Harris, A.Y. Jackson, Franz Johnston, Arthur Lismer, J. E. H. MacDonald, and Frederick Varley. They befriended each other in Toronto between 1911 and 1913, where all except Harris made their living as commercial artists. The friends were initially drawn together by a common sense of frustration with the conservative and imitative quality of most Canadian art at the time. The members’ style was derived to a great extent from European post-impressionism and their landscapes often depict rugged northern Ontario scenes. Romantic, with mystical leanings, the Group and their spokesmen zealously, and sometimes contentiously, presented themselves as Canada’s national school of painters. The Group of Seven disbanded in 1933, but paintings by its members can nowadays be

¹³² I am grateful to Scott James, Archivist at the Arts and Letters Club, for providing me details about Defries’s biography.

¹³³ <http://www.thecanadianencyclopedia.com/index.cfm?PgNm=TCE&Params=A1ARTA0003476> (accessed August 5, 2009).

found in most Canadian public art galleries and they are highly valued collector's items.

Wolfgang Grunsky¹³⁴

Wolfgang Grunsky (1902–91) was born in Friedrichshafen on Lake Constance, in Southern Germany. His father was a government official whose job required him to move around a fair amount. As a child, Wolfgang spent time in Munster and Ulm. He took up the cello at age thirteen, and studied music formally at the Stuttgart Conservatory of Music with Alfred Saal and then at the State Academy of Music in Vienna with the renowned cellist and gambist Paul Grümmer. Grümmer is the one who introduced Grunsky to the viola da gamba; early music was to be a lifelong passion.

After completing his formal education in 1926, Grunsky spent a year as principal cellist in the Regensburg and Dresden Symphony orchestras, and started a career as a solo cellist. In 1927 he was appointed teacher of cello and chamber music at the Mozarteum in Salzburg. Shortly thereafter he formed the Salzburg Mozart Quartet, with which he toured for ten years. After World War II, Grunsky concentrated his efforts on forming an ensemble of viols and other early instruments. He founded the Graz Chamber Orchestra, an ensemble of 35 period instrument players, whose crowning achievement was a performance of Grunsky's own orchestration of J. S. Bach's *The Art of Fugue*.

In 1951, Grunsky was encouraged by Arnold Walter, then Director of the University of Toronto, to immigrate to Canada, where the field of early music had not yet been greatly cultivated. Grunsky moved to Toronto, accepting posts teaching viol at the University of Toronto and recorder and cello at the Royal Conservatory of Music, where he taught until 1989. He was also a cellist in the Toronto Symphony from 1954 to 1972. In 1952, Grunsky was given access to the Hart House viols. He directed ensembles that used those viols for more than twenty performances over the course of sixteen years. In concert, Grunsky performed on his own

¹³⁴ I am grateful to Michael Grunsky, Wolfgang's son, who provided much of this information.

bass viol, described as by Giovanni Grancino, Milan 1624. His wife, Maria, also played and owned a treble viol by Karla Rotta, made in Prague in 1863.¹³⁵

Lawren Harris¹³⁶

Lawren Stewart Harris was born in 1885, the son of Thomas Morgan Harris, secretary of A. Harris, Son and Co. Ltd., a manufacturer of farm machinery, which in 1891 amalgamated with the Massey Manufacturing Company to form the Massey-Harris Co. Ltd. Lawren Harris was thus a rich man, and also family friends with Vincent Massey. A catalyst and leader in the creation of the Group of Seven, he was a magnificent landscape painter, transforming the powerful forms of nature into works of force and elegance. He died in 1970.

James MacCallum¹³⁷

James Metcalfe MacCallum was born in 1860 and received BA and medical degrees from the University of Toronto. He spent a further two years studying at Moorfields Hospital in London, England, training as an eye specialist. Returning to Toronto in 1888, he established a practice as an oculist and ophthalmologist. MacCallum's contribution to Canadian culture was seminal; he encouraged the members of the Group of Seven to pursue their art and exhibit frequently, promoted them through his own purchases, and directed others to their work. His earliest connections with artists came through Toronto's Arts and Letters Club. MacCallum, a passionate woodsman, encouraged artists to visit his cottage on Georgian Bay; the idyllic if wild setting inspired them to produce paintings that could truly be described as "Canadian" in content and style. In 1914, wishing to consolidate the well-being of the

¹³⁵ The Viol List.

¹³⁶ <http://www.thecanadianencyclopedia.com/index.cfm?PgNm=TCE&Para ms=A1ARTA0004865> (accessed August 5, 2009).

¹³⁷ <http://national.gallery.ca/english/library/biblio/ngc014.html> (accessed August 5, 2009). Robert Burford Mason, "Dr. James MacCallum: Patron and Friend of Canada's Group of Seven," *Canadian Medical Association Journal* 155 no. 9 (Nov. 1, 1996).

group of painters who were his friends and in whose talent he had such an abundant belief, MacCallum helped finance the Studio Building, a purpose-built combination of accommodation and studio space for artists, which still stands on Severn Street in Toronto. MacCallum died in 1943. His papers are part of the National Gallery of Canada Library and Archives.

Vincent Massey¹³⁸

Charles “Vincent” Massey was born in 1887 in Toronto, the son of Chester Massey, the owner of Massey-Harris Co. and patriarch of one of the city’s wealthiest families. The family was strongly Methodist, and played an important role in supporting local religious, cultural, and educational organizations, including Victoria University, Massey Hall, and the Metropolitan Methodist Church (now the Metropolitan United Church). Massey attended University College at the University of Toronto and graduated in 1910 with a BA in history and English. He continued his education at Balliol College at the University of Oxford, earning an MA in history. In 1913, he returned to Toronto and became the first Dean of Men at the Victoria University. In 1919 he formed the Massey Foundation from his grandfather Hart Almerrin Massey’s estate. Hart House, named in honor of his grandfather, was opened in November, 1919. Massey enjoyed a long career of public service as a politician and government representative abroad. From 1949 to 1951 he served as Chairman for the Royal Commission on National Development in the Arts, Letters, and Sciences. In 1951 they produced the “Massey Report” advocating the creation of government-sponsored organizations that would support Canadian arts, which led to the formation of the National Library of Canada and the Canada Council of the Arts. From 1952 to 1959 Massey served as the first Canadian-born Governor-General of Canada. An archive of Massey’s personal documents is housed at the University of Toronto, UTA Accession No. B87-0082.

¹³⁸ <http://content.library.utoronto.ca/utarms/researchers/Fonds/massey> and http://en.wikipedia.org/wiki/Vincent_Massey (accessed August 5, 2009).

Roy Mitchell¹³⁹

Roy Matthews Mitchell was born in 1884 and attended the University of Toronto. Mitchell was the driving force behind the theatrical activity of the Arts and Letters Club, where dramatic dinner entertainment was a tradition. Under his leadership, the Arts and Letters Players became the foremost group in Toronto's amateur theater scene. Partly due to Mitchell's rebellion against the realistic style popular at the time, partly because of physical limitations, they adopted a highly stylized expressionistic style far in advance of other groups. He is credited for helping to establish and popularize the "Little Theatre" movement. In 1916 Mitchell studied stage design in New York. He worked for a while as a stage manager on Broadway, and in 1917 became technical director of the Greenwich Village Theatre in its first season. In 1918 he returned to Canada, working as Director of Motion Pictures for the Canadian Department of Public Information, and became first Director of the Hart House Theatre when it opened in 1919. Mitchell seized on the potential of new equipment, which he saw not only as a technical innovation but as a means to create a totally new approach to theater, and used Hart House as a laboratory where he tested new ideas and techniques. Most of the rest of Mitchell's career was spent in New York. Besides numerous contributions to journals, he left three books: *Shakespeare for Community Players* (1919), *The School Theatre* (1925), and *Creative Theatre* (1929). An archive of Mitchell's documents is housed at York University (in Downsview, Ontario), Inventory #F0358.

Peggie Sampson¹⁴⁰

Margaret ("Peggie") Sampson was born in Edinburgh on February 16, 1912. She began cello lessons at age eight with Ruth Waddell in Edinburgh and continued with Guilhermina Suggia in London and Portugal. She was pupil (1929–32) and teaching assis-

¹³⁹ Renate Usmani, "Roy Mitchell: Prophet of Our Past," *Theatre Research in Canada* 8, no. 2 (Fall 1987).

¹⁴⁰ <http://www.thecanadianencyclopedia.com/index.cfm?PgNm=TCE&Para ms=UIARTU0003097> (accessed August 5, 2009). Ken Winters, "Peggie Sampson 1912–2004: A Musical Life of the Mind," *Toronto Globe and Mail*, June 29, 2004.

tant (1937–44) to Donald Francis Tovey at the University of Edinburgh and during the summers of 1930–34 in Paris studied cello with Diran Alexanian at the École normale and theory privately with Nadia Boulanger. During the 1930s Sampson gave recitals in England and Holland, performed the Elgar Concerto under Tovey, and played in the Glyndebourne Festival orchestra under Fritz Busch. She also studied intermittently from 1935 to 1937 with Emanuel Feuermann and c.1946 with Pablo Casals in Prades. She freelanced as a cellist from 1944 to 1951 in London, giving recitals and playing as part of the Carter Trio.

Sampson immigrated to Canada in 1951 to teach theory, music history, and cello at the University of Manitoba, where she remained for 20 years. She became a naturalized Canadian in 1973. She also taught cello privately in Winnipeg and in 1962 received a special grant from the University of Manitoba to set up an experimental class for unusually gifted children (she had spent a year 1960–61 in Great Britain completing a doctorate in performance and studying new methods of music education for the young). She was extremely active as a cellist in Winnipeg during the 1950s and 1960s, appearing as solo recitalist, as a member of the Corydon Trio, and in various ensembles for the University Chamber Music Group.

Around 1960 Sampson began to develop an interest in the viola da gamba and collaborated with Christine Mather to found the Manitoba University Consort (1963–70). By the end of the 1960s the gamba had superseded the cello as her main instrument. In 1970 she joined the staff at York University in Downsview, Ontario, to teach theory and develop a program for viols. Invited three times to the Aldeburgh Festival, she gave recitals there in 1972 and also participated in the 1974 festival. In the 1970s, she and the Hart House Consort of Viols gave numerous recitals. In 1973–75 she taught at the University of Victoria Summer School, and after retiring in 1977 from York University taught part-time from 1977 to 1984 and on occasion thereafter at Wilfred Laurier University. She also played and taught at the 1977 Conclave of the Viola da Gamba Society of America in Baltimore.

In 1976 Sampson formed *Quatre en Concert* with Christine Harvey (soprano), Michael Purves-Smith (oboe), and Deryck Aird

(violin), to perform music of the seventeenth and eighteenth centuries. They toured Ontario in 1976, from Montreal to Saskatoon in 1977, and Holland in 1978. Their last professional engagement was to record music by Purcell, Jenkins, Campora, Rameau, and Handel in 1981 (Damzell DLM-812). Sampson received a BMus Degree (Edinburgh) in 1932, the Licence de Concert (École normale, Paris) in 1932, DMus (Edinburgh) in 1961, an honorary LLD (Wilfrid Laurier) in 1987, and honorary DLitt (York) in 1988, and was awarded the Canadian Music Council medal in 1985. She died in Toronto on May 17, 2004. Her viols and materials from her estate are located at York University.

Leo Smith¹⁴¹

Joseph Leopold “Leo” Smith was born in Birmingham, England in 1881. A child prodigy, he gave his professional recital debut on the cello at the age of eight at the Birmingham Town Hall. Smith’s parents were well-to-do; on his mother’s side, he was a Turnour, directly descended from the Lord Chief Baron of the Exchequer to Charles I and a family of landed dignitaries since the time of Henry IV. On his father’s side, he was a descendant of the Blood family from Stratford-on-Avon, who owned the house where Shakespeare was born. Leo Smith attended the Birmingham Midland Institute of Music, the Royal Manchester College of Music, and Manchester University. His primary cello teacher was Carl Fuchs, though he also became very proficient as a composer. Upon graduation he became a member of the Hallé Orchestra, and later took a position in the Covent Garden Orchestra in London, in addition to numerous chamber music collaborations.

In 1910 Smith moved to Canada and soon thereafter became a member of the Toronto [Conservatory] Symphony Orchestra. Within a few months of his arrival in Toronto, Smith’s compositions started to be performed in the area and received much critical acclaim. From 1911 he taught at the Toronto Conservatory of Music and also founded one of the few chamber ensembles of that time, the Toronto String Quartet. In 1918 he became the editor for

¹⁴¹ McCarthy, Pearl, *Leo Smith: A Biographical Sketch* (Toronto: University of Toronto Press, 1956).

the newly created quarterly magazine published by the Toronto Conservatory, and his writing skills later resulted in the publication of a textbook, *Musical Rudiments* (1920) and a historical survey, *Music of the 17th and 18th Centuries* (1931). In 1934 Smith became the music critic for the Toronto *Globe and Mail*.

Smith's interest in education was apparent in many ways. In addition to his connections with the Toronto Conservatory, in 1927 he became a lecturer at the University of Toronto. When the University established a Music Faculty in 1938, Smith became a professor of cello. Smith also had a strong connection with Hart House, where many of his compositions were presented. From 1932, as a member of the Conservatory String Quartet, he enjoyed regular use of the Hart House viols, favoring the Tielke bass. He also served on the executive board of the Toronto Musicians' Association from 1946 to 1951. Smith died in Toronto on April 18, 1952.

Elie Spivak¹⁴²

Elie Spivak was born in Uman, Ukraine on February 2, 1902. He studied violin with Henri Berthelier at the Paris Conservatory from 1910 to 1915 and with Adolf Brodsky at the Royal College of Manchester in 1916. In Manchester, in 1923, he founded the Elie Spivak String Quartet, the first ensemble to give chamber music concerts over the new BBC network. After a year in New York he moved to Toronto, where he established a performing and teaching career. He was first violin of the Conservatory String Quartet from 1929 to 1942 and concertmaster of the Toronto Symphony Orchestra from 1931 to 1948. In 1945 he gave the North American premiere of the Khachaturian Violin Concerto with the Boston Pops Orchestra. Many of Spivak's students have occupied important teaching and playing posts across Canada and in the U.S. His playing was known for warmth of tone and depth of feeling. Colleagues recall his sensitivity and gentleness as an artist and as a man. He died in Toronto on July 23, 1960.

¹⁴² <http://www.thecanadianencyclopedia.com/index.cfm?PgNm=TCE&Params=U1ARTU0003290> (accessed September 5, 2009).

Henry Sproatt and Ernest Rolph¹⁴³

The Canadian architectural partnership of Sproatt & Rolph was formed in 1899. Henry Sproatt (1866–1934) is generally credited as the firm's designer, Ernest Rolph (1871–1958) as its engineer. Although their works span a range of styles, Sproatt & Rolph are considered Canada's chief exponents of modernized Gothic architecture. The firm was responsible for numerous institutional, commercial, and residential buildings in Toronto, including Hart House and the Memorial Tower at the University of Toronto, which won the American Institute of Architects Gold Medal in 1926. Other important buildings in Toronto that were designed and erected by Sproatt & Rolph are Victoria College (1910), Burwash Hall (1911–13), Manulife South Tower (1926), College Park (1928–29), Fairmont Royal York Hotel (1929), Canada Permanent Trust Building (1930), Canada Life Building (1931), Knox Presbyterian Church (1932), Emmanuel College (1932), Princess Margaret Hospital (1935), the Bishop Strachan School, the Ontario Club and the National Club.

¹⁴³ <http://www.answers.com/topic/sproatt-rolph-2>,
http://en.wikipedia.org/wiki/Henry_Sproatt,
<http://www.thecanadianencyclopedia.com/index.cfm?PgNm=TCE&ArticleId=A0007631>,
<http://www.emporis.com/application/?nav=company&lng=3&id=110653> (all accessed August 5, 2009).

Appendix 3: Performances on the Hart House Viols Under Grunsky's and Sampson's Direction

Main viol performers' names in Wolfgang Grunsky's concerts are abbreviated: Wolfgang Grunsky, Joyce Gundy, Doreen Hall, Eileen Bordessa, Klemi Hambourg, Berul Sugarman, Macey Cadesky, William (Bill) Kuinka.

Main viol performers' names in Peggie Sampson's concerts are abbreviated: Peggie Sampson, Christel Thielmann, Rosamund Morley, Murray Charters, Alison Mackay, David Hirschorn, Gregor Brown.

February 18, 1953

Toronto: Hart House, Wednesday Afternoon Recital, under the name "The Viols Quintet," with Grunsky, Gundy, Hall, plus Ronald Laurie (cello) and Diane Parker (mezzo-soprano).

November 8, 1953

Toronto: Hart House, Sunday Evening Concert Series, 250th Concert, in the Great Hall, under the name "Wolfgang Grunsky Group of Viols," with Grunsky, Gundy, Hall, Bordessa, Hambourg, plus Elizabeth Benson Guy (soprano) and Greta Kraus (harpsichord).

May 1953 (exact recording and broadcast dates unknown)

Toronto: CBC broadcast, Music of the Elizabethans, under the name "Wolfgang Grunsky Group of Viols," with Grunsky, Gundy, Hall, Bordessa, Hambourg, plus Hugh Orr (recorder) and Lois Marshall (soprano).

July 18, 1954

Toronto: Trinity College Shakespeare Festival, Elizabethan Concerts (9:00 p.m.), under the name "Wolfgang Grunsky Group of Viol Players," with Grunsky, Gundy, Hambourg, Maria Grunsky, plus Madame Kohlund (soprano).

February 16, 1955

Toronto: Hart House, 5 O’Clock Recital “directed by Wolfgang Grunsky,” with Grunsky, Gundy, Bordessa, Maria Grunsky, plus Elisabeth Gallimore (alto recorder).

July 29, 1956

Toronto: Trinity College Earle Grey Shakespeare Festival, Second Elizabethan Concert (9:00 p.m.), under the name “Wolfgang Grunsky’s Recorder Group,” with Grunsky and Maria Grunsky (recorders and viols), plus Joyce Gundy (treble recorder), Rodger Chittenden (tenor and bass recorders), and Hans Kohlund (singer and lutenist).

August 5, 1956

Toronto: Trinity College Earle Grey Shakespeare Festival, Third Elizabethan Concert (9:00 p.m.), under the name “Wolfgang Grunsky and His Viol Players,” with Grunsky, Gundy, Bordessa, Maria Grunsky, plus Isabelita Alonso (mezzo-soprano).

July 14, 1957

Toronto: Trinity College Earle Grey Shakespeare Festival, Elizabethan Concert (9:00 p.m.), under the name “Wolfgang Grunsky Consort,” with Grunsky, Gundy, Bordessa, and Maria Grunsky.

September 25, 1957

Toronto: Concert Hall of the Royal Conservatory of Music (8:30 p.m.), under the name “The Wolfgang Grunsky Consort,” with Grunsky, Gundy, Bordessa, Maria Grunsky, plus Roger Chittenden (recorders), Christian Schmid (recorders), and Hans Kohlund (lute).

June 13, 1962

Toronto: The Art Gallery of Toronto (12:30 p.m.), under the title “Music of the Renaissance by the Toronto Renaissance Trio,” with Grunsky, Gundy, plus Hans Kohlund (lute and recorder).

February 6, 1963

Toronto: Hart House, Wednesday 5 O'Clock Recital, under the name "The Toronto Renaissance Quintet," with Grunsky, Gundy, Sugarman, Boris Kersting, plus Hans Kohlund (lute and recorder).

June 11, 1963

Toronto: The Art Gallery of Toronto, Free Chamber Music Concerts (12:30 p.m.), under the name "The Toronto Viol Quintet," with Grunsky, Gundy, Sugarman, Cadesky, Boris Kersting, plus Hans Kohlund (lute and recorder).

November 3, 1963

Toronto: University of Toronto, Concert Hall at the Edward Johnson Building, Ten Centuries Concerts (8:55 p.m.), under the title "The Toronto Renaissance Quintet under the direction of Wolfgang Grunsky," with Grunsky, Gundy, Sugarman, Cadesky, Boris Kersting, plus Hans Kohlund (lute and singer).

July 15, 1964

Toronto: Hart House, Wednesday Afternoon Recital, in the Music Room, under the name "The Toronto Renaissance Quintet," with Grunsky, Gundy, Sugarman, Cadesky, Kuinka, plus Ingrid Fistell (soprano and percussion).

December 11, 1964

Toronto: Goethe House Concert, under the title "The Toronto Renaissance Quintet under the direction of Wolfgang Grunsky," with Grunsky, Gundy, Sugarman, Cadesky, Kuinka, plus Ingrid Fistell (soprano and percussion).

February 10, 1965

Toronto: Hart House, Wednesday 5 O'Clock Recital, under the name "The Toronto Renaissance Quintet," with Grunsky, Gundy, Sugarman, Cadesky, Kuinka, plus Ingrid Fistell (soprano, percussion, and lute).

February 21, 1965

Toronto: Victoria College, Wymilwood Sunday Evening Concert series (9:00 p.m.), under the title “The Toronto Renaissance Quintet,” with Grunsky, Gundy, Sugarman, Cadesky, Kuinka, plus Ingrid Fistell (soprano, percussion, and lute).

June 24, 1965

Toronto: The Art Gallery of Toronto, Free Chamber Concert (12:30 p.m.), under the title “The Toronto Renaissance Consort,” with Grunsky, Gundy, Sugarman, Cadesky, Donald Whitton, plus Giuseppe Macina (tenor).

May 1966 (exact date unknown)

Parry Sound: The Canadian Club of Parry Sound, Chamber Music Concert, under the title “The Toronto Renaissance Quintet,” with Grunsky, Gundy, Cadesky, Kuinka, plus Ingrid Fistell (soprano, percussion, and lute).

May 31, 1966

Toronto: The Art Gallery of Toronto, Free Chamber Concert (12:30 p.m.), under the title “The Toronto Renaissance Consort,” with Grunsky, Gundy, Cadesky, plus Ingrid Fistell (soprano and percussion).

March 14, 1969

Waterloo: University of Waterloo, Theatre of the Arts, under the title “Renaissance Consort,” with Grunsky, Gundy, Cadesky, Kuinka, plus Ingrid Fistell (soprano, percussion, lute, and treble viol).

.....

November 10, 1974

Toronto: Hart House, Sunday Evening Concert Series, 405th Concert, in the Great Hall, under the name “York Consort of Viols,” with Sampson, Thielmann, Morley, Charters, Mackay, plus Henriette Asch (soprano), Jon Higgins (baritone), and Michael Kearns (harpsichord).

January 23, 1975

Toronto: Town Hall at the St. Lawrence Centre (8:30 p.m.), under the title "First Evening: Two Evenings with Peggie Sampson (viol) and Kenneth Cooper (harpsichord)," with Sampson, Cooper, Thielmann, Morley, Charters, and Mackay.

January 24, 1975

Toronto: Town Hall at the St. Lawrence Centre (8:30 p.m.), under the title "Second Evening: Two Evenings with Peggie Sampson (viol) and Kenneth Cooper (harpsichord)," with Sampson, Cooper, Thielmann, Morley, Charters, Mackay, plus Douglas Stewart (flute), Henriette Platford (soprano), Janet Stubbs (mezzo), John Martens (tenor), and Jon Higgins (baritone).

March 24, 1975

London: University of Western Ontario, Faculty of Music Recital Hall (8:30 p.m.), under the title "Music for Viol Consort," with Sampson, Thielmann, Mackay, plus Pat Hanley (viol), Michael Longton (harpsichord), and Katharine Pimenoff (soprano).

May 10, 1975

Toronto: Hart House, workshop and concert, final performance in the Music Room (8:00 p.m.), under the name "York Consort of Viols," with Sampson, Thielmann, Morley, Charters, Mackay, plus Katharine Pimenoff (soprano) and Jon Higgins (baritone). Workshop was with Sampson, Thielmann, Morley, Charters, and Mackay, and ran 9:30 a.m. to 4:30 p.m.

September 12, 1975

Downsview: McLaughlin College at York University, McLaughlin Senior Common Room (4:00 p.m.). No other details known.

September 14, 1975

CBC-TV: Music to See (5:00 p.m.), program recorded on May 26, 1975 under the title "Peggie Sampson and Friends," with Sampson, Thielmann, Morley, Mackay, Charters, plus Eugene Stecky (viol) and Carol Birtch (harpsichord).

October 4, 1975

Buffalo, New York, USA: Fall Meeting of the New York State Chapter of the American Musicological Society, State University of New York at Buffalo, Baird Recital Hall (1:00 p.m.), under the title “Hart House Consort of Viols: The Laws of Dissonance, or the Dissonance of Lawes: A Practical Adventure in Sonority.” Performers other than Peggie Sampson not known.

October 14, 1975

Downsview: York University Department of Music in room Curtis ‘F’ (12:00 noon), under the title “Hart House Consort of Viols Performing Consort Music of William Lawes (1602–1645),” with Sampson, Thielmann, Morley, Charters, Mackay, and Hirschorn.

January 29, 1976

Guelph: Guelph University, Thursday Noon Concert series in the Music Room (two performances, at 12:10 and 1:10 p.m.), under the title “Hart House Consort of Viols,” with Sampson, Morley, Charters, Mackay, Hirschorn, Brown, plus Garry Crighton (countertenor).

February 20, 1976

Dundas: Te Deum Concert Series at St. James Church (8:15 p.m.), under the title “Music for Viols and Voices,” with Sampson, Morley, Charters, Mackay, Hirschorn, Brown, plus Richard Birney Smith (organ), Neil McLaren (bass), and the Te Deum Singers (24-voice choir).

February 29, 1976

Toronto: Arts and Letters Club (no time or room specified), under the title the “Hart House Consort of Viols,” with Sampson, Morley, Charters, Mackay, Hirschorn, and Brown.

February 29, 1976

Toronto: Victoria College, Wymilwood Concert series (8:00 p.m.), under the title “Music for Viols and Voices,” with Sampson, Morley, Charters, Mackay, Hirschorn, Brown, plus Garry Crighton (countertenor).

March 11, 1976

Waterloo: Wilfred Laurier University, Faculty of Music Theatre Auditorium, Music at Noon series (12:30 p.m.), under the title "Hart House Consort of Viols," with Sampson, Morley, Charters, Mackay, Hirschorn, Brown, plus Miles Dempster (lute).

March 17, 1976

Toronto: Royal Ontario Museum, Bishop White Gallery (5:30 p.m.), under the title "Hart House Viols." Performer names not known, but program included pieces for three- to six-part viol consort (Lawes, Jenkins, Purcell, Coperario, Lupo, and Locke), plus music for both Renaissance and Baroque flutes.

October 24, 1976

Toronto: David Mirvish Gallery, presented by The Faculty of Fine Arts Department of Music at York University and the David Mirvish Gallery (4 p.m.), under the title "Hart House Consort of Viols in English Music of the Seventeenth Century," with Sampson, Thielmann, Morley, and Mackay.

November 27, 1976

Toronto: Hart House Music Room (8:30 p.m.), under the title "Hart House Consort of Viols: English Viol Music of the 17th Century." Performer names not known, but Paul O'Dette (lute) was a guest.

January 27, 1977

Toronto: Art Gallery of Ontario at The Grange (8:00 p.m.), under the title "Hart House Consort of Viols." Performer names not known, but program included viol consort music (Jenkins, Locke, Byrd, Purcell), as well as lute duos (Johnson, Pilkington, Alison, Phillips, Ford) and lute songs (Dowland, Rosseter, Wilbye, East, Nicholson).

February 19, 1977

Toronto: Hart House Music Room (8:30 p.m.), under the title "Hart House Consort of Viols: Musique à la Cour de Versailles,"

with Sampson, Thielmann, Morley, Mackay, plus Michael Purves-Smith (harpsichord).

April 23, 1977

Toronto: Hart House Music Room (8:30 p.m.), under the title “Hart House Consort of Viols: German Music for Viol Consort and Tenor Solo,” with Sampson, Thielmann, Morley, Mackay, Hirschorn, plus Brian Franklin (viol), Jon Higgins (tenor), and Bruce Ubukata (organ).

May 15, 1977

CBC-TV: Music to See (time unknown), under the title “Hart House Consort of Viols,” with Morley, Mackay, Hirschorn, plus Bruce Ubukata (harpsichord). Also rebroadcast on July 2, 1978.

TWIN VIOLS: EVIDENCE FOR SERIAL PRODUCTION IN THE WORKSHOP OF NICOLAS BERTRAND

Thomas Fitz-Hugh Mace

Abstract

Despite the generally accepted notion that early viols by a single maker were variable in size, designed during construction, and built without forms, two bass viols by the Parisian maker Nicolas Bertrand (d. 1725) turn out to be virtually identical and highly symmetrical. Nonetheless, their internal construction, reminiscent of seventeenth-century English work, shows that they were not built using the violin-style forms that later became the norm. This article explores the methods used in the construction of these instruments.

An examination of Bertrand's workshop based on a detailed death inventory from 1725 reveals a large and commercially ambitious establishment where a number of workmen assisted the master. Finished instruments, materials, and semi-finished parts were stockpiled in large quantities and instruments were apparently built in batches. Rather than commissioned work, the shop's commercial orientation was mainly towards stock-in-trade, a relatively new approach in bowed stringed instrument making that fostered standardization.

Bertrand's workshop may have achieved the desired standardization and adherence to design by building viols using a form of the type illustrated in Diderot's *Encyclopédie*. This hypothesis requires a re-examination of this well-known image, which has been discussed in the literature with other, differing interpretations. A practicable method is shown for using a form of this type to build symmetrical, repeatable instruments with the internal characteristics of the Bertrand viols in question. An appendix gives detailed descriptions of the instruments that form the basis of the article.

Over the past year, I have had the good fortune to be able to examine and measure two well-preserved seven-string bass viols by the great eighteenth-century Parisian maker Nicolas Bertrand, whose instruments were as well regarded at his death in 1725 as they are today. Both of these instruments are now in the United States. The first, dated 1720, is in the Metropolitan Museum of Art in New York and the other, without date, is in the Caldwell Collection in Oberlin, Ohio.

Bertrand was a prolific maker, and a gratifyingly large number of his bass viols—sixteen at the most recent count—have sur-

vived.¹ I have only seen a fraction of this total over the years, but those I have examined show great consistency in concept, style, and execution. The two instruments that form the basis of this study are very characteristic of his work in general, but because they are less well known than certain of their European siblings, I have described them in some detail in an appendix to this paper.

The New York instrument in particular is very well preserved. Although it was crudely adapted for cello stringing at some early point in its history, it has its original head, the core of its original neck and fingerboard, and something like its original string length and neck setting. The interior, except for a few added reinforcements, is essentially untouched. All of its fittings except the bridge, pegs, and nut are preserved.

The Caldwell instrument has been more significantly altered. In mid-nineteenth-century Genoa, it was rebaptized as a Carlo Bergonzi, a change that necessarily involved the removal of Bertrand's brand-mark on the heel, any then-existing label, and various internal modifications. Later, the instrument passed through the Dolmetsch workshop. At some point in this history, most probably in Italy, it was converted into an arpeggione-like "lyra viol" complete with fixed frets and twelve sympathetic metal strings, an alteration that entailed the loss of the head, neck, and all fittings. The body of the viol remains well preserved, and the instrument is currently set up as a seven-string viol.

Both instruments retain many traces of Bertrand's concept and working methods, but for me the most surprising discovery was that the two are virtually twins, as close in outline and detail as could be expected from an expeditious eighteenth-century worker. Figure 1 shows just how close they are. Both have highly congruent outlines, precisely the same length from bottom to fold, the same corner heights, and nearly identical shoulder profiles. Figure 2, superimposing the top layout of both instruments aligned on the center join, shows clearly that the soundholes were marked out using the same method and cut to the same design. Figures 3 and 4

¹ Private communication from Thomas G. MacCracken, March 2009, based on his Viol List, a comprehensive database of all extant viols made before the twentieth century. This database continues the work of Peter Tourin's *Viollist* (Duxbury, VT: The Tourin Musica, 1979).

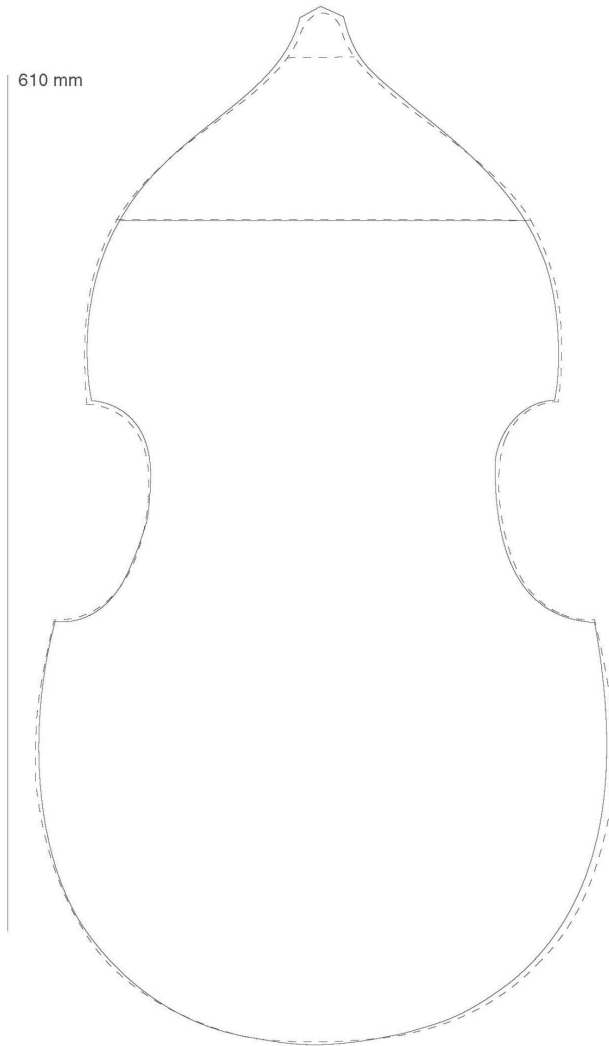

Figure 1. The back outline of the 1720 New York Bertrand is shown in solid lines; the back outline of the undated Oberlin Bertrand is shown in dotted lines. Both are shown to identical scales. The shoulder portions above the folds are shown unfolded. The matching method is “best fit.” The dotted line across the heel section of the Oberlin Bertrand shows the lower edge of a mid-nineteenth-century addition; the heel profile of this viol is not original. The match between the two viols is striking.

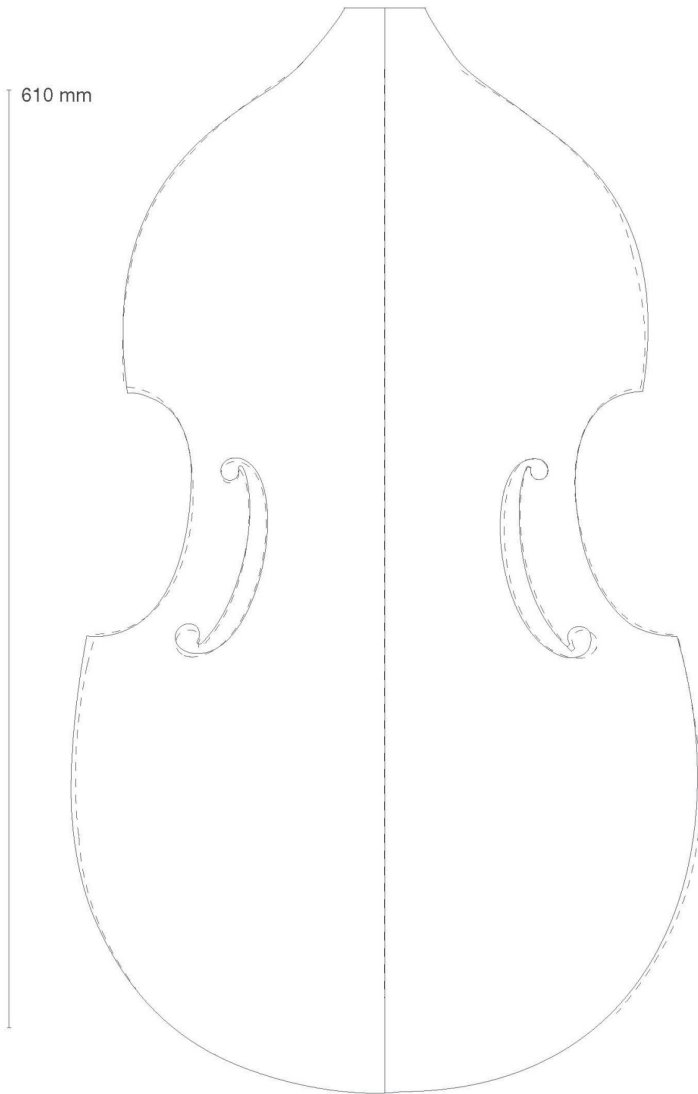

Figure 2. The front outline of the 1720 New York Bertrand is shown in solid lines; the front outline of the undated Oberlin Bertrand is shown in dotted lines. Both are shown to identical scales. The match is horizontally aligned on the center joint of both plates. Vertical alignment is “best match.” The soundholes of both viols were obviously positioned according to the same scheme and cut to the same design.

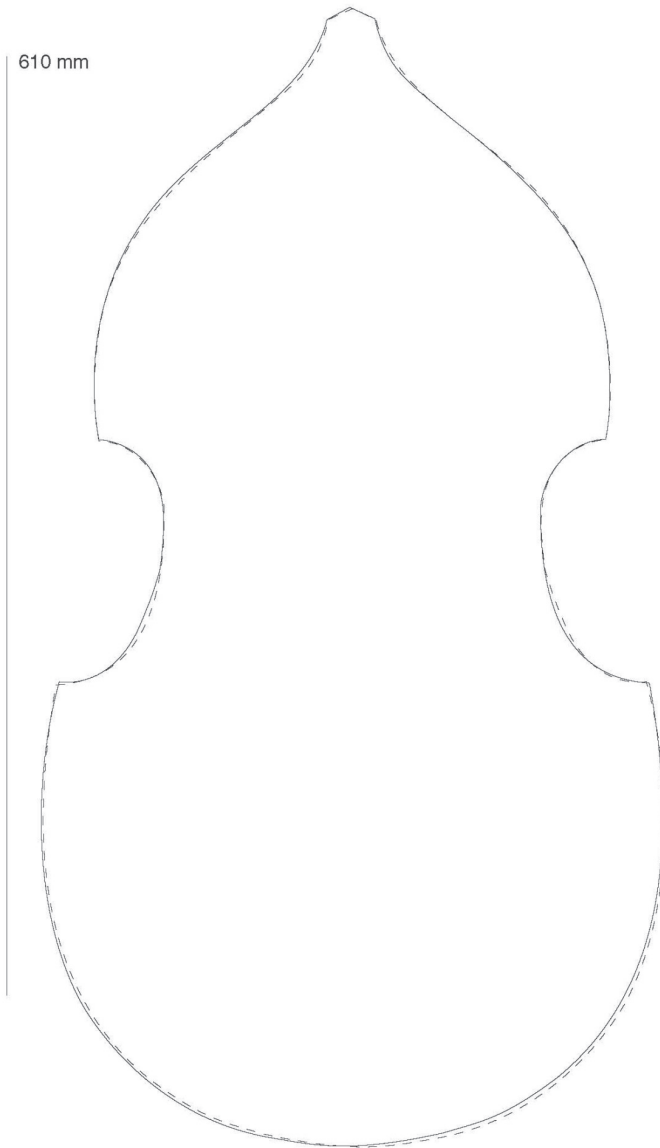

Figure 3. The back outline of the New York Bertrand (solid) compared to its own mirror image (dotted). The matching method is “best fit.” The outline of this viol is very symmetrical except for small divergences in the midsection of the center bouts.

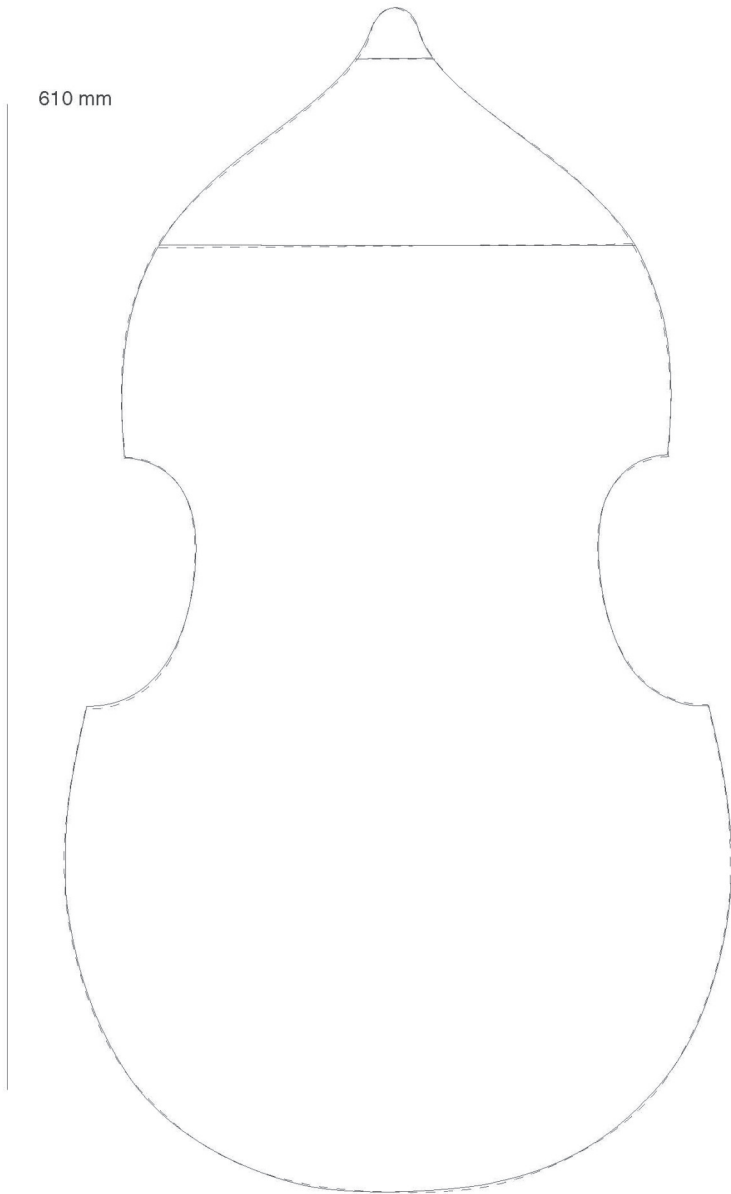

Figure 4. The back outline of the Oberlin Bertrand (solid) compared to its own mirror image (dotted). The matching method is “best fit.” The outline of this viol is highly symmetrical.

show that each instrument is highly symmetrical in and of itself, with the left- and right-hand side of each matching closely.

This might seem a banal discovery. Surely, Bertrand built both using the same template or mold? I will argue that this was indeed the case, but we should begin by registering profound skepticism as to this point. After all, the use of forms or molds of any kind is considered so rare in classical viol making as to be almost contrary to the nature of “violness” itself. On this point, Annette Otterstedt gives sweeping expression to what I think is a general consensus:

The inner mould was an invention of the lute makers, who needed it to assemble lute bodies from lots of wobbly ribs.... We do not know whose idea it was to use the same method for making violins or why. But neither is there anything to suggest that viols were ever standardized the way violins were. On the contrary, a maximum of variety was intended, and all viols are different, including those made by one and the same maker.²

This sort of form-free construction seems particularly well established for English viols. Michael Fleming, looking rigorously at a group of thirty-eight English viols datable between 1580 and 1660, found such a general lack of consistency in sibling instruments by such makers as Richard Blunt, Henry Jaye, John Rose, and William Turner that he concluded:

Viols by a single maker often resemble one another but are not exactly the same size and shape as each other, either as a whole or in detail. This is evidence that makers were free both from theoretical constraints that insist on certain sizes or relationships between parts of an instrument, and also from the repeatability of shape which is one of the principal features of instrument construction which uses a mould.³

Fleming also finds considerable variations in left/right symmetry among these instruments, which he reports as being frequently over 5 mm. He finds that soundhole shape and placement within a maker’s work are also open to considerable variation.

² Annette Otterstedt, *The Viol: History of an Instrument*, trans. Hans Reiners (Kassel: Bärenreiter, 2002): 233-234.

³ Michael Fleming, “Viol-Making in England c.1580-1660” (PhD diss., The Open University, 2001), 70–71 (CD-ROM).

Benjamin Hebbert, studying the later English maker Barak Norman, notes the continuum of sizes of his bass viols and observes:

The reality is that for whatever reason, there is no pattern to the sizes of his instruments which exist at every size imaginable from 620 mm to 730 mm. Therefore, English makers certainly did not use moulds ... and were making instruments individually for the specific needs of the clientele.⁴

In the case of the Bertrand instruments, the strongest reason for believing that they were not built on Cremonese-style molds lies in details of their inner construction. We look in vain for corner blocks, top and bottom liners, lapped corners at the middle bouts, a nail-reinforced butt joint of the neck, or any of the other violin-like structures that we normally associate with instruments built on an inner form. Instead, we find a decidedly older style of construction. The corners of his middle bouts are mitered and reinforced with nothing more than parchment strips and glue. The back and sides, heavily scored on the interior with a tooth plane, are glued together without liners and also reinforced with linen and parchment. Apart from Bertrand's characteristic through-neck in lieu of a top block, a strikingly archaic technique in itself,⁵ one could almost mistake his workmanship for that of a maker such as Richard Meares. If his instruments look like old English work on the inside, it is only natural to assume that they were built that way too.

The very close match between the outlines of Bertrand's viols shown above, their uniform belly layout, and their very accurate

⁴ Benjamin Hebbert, "The Geometry of Early English Viols," *Transcripts of the British Violin Makers Conference*, Dartington, 2007: 3. I quote an Internet-published adaptation of this lecture prepared by the author. <http://oxford.academia.edu/BenjaminHebbert/Papers>.

⁵ *Through-neck* refers to a technique for connecting the neck to the body of an instrument, where the back, sides, and belly are glued directly to the neck stock, which, for this purpose, extends a few centimeters into the body. This is distinct from the *top block* construction typically found in English viols, where the sides, back, and belly are glued to a separate shaped block of wood inside the shoulders of the viol, to which the neck proper is dovetailed and nailed. Through-neck construction is found not only in viols by Bertrand and Collichon but in many violin-family instruments of Dutch, English, and Allemanic origin. A surviving fragment of an original viol neck by Jacob Stainer shows that he used this technique as well.

left-right symmetry tell a different story and pose an interesting question: How did Bertrand build these twin viols? Free-form and inner-form construction are usually discussed as mutually exclusive alternatives. Here, in the work of an important maker in a musical culture of great importance, we seem to have a “third way,” a technique that allowed for traditional interior construction but also yielded a symmetrical and repeatable instrument. When we look at how the work in Bertrand’s shop was carried out, as mirrored in an inventory from 1725 drawn up immediately upon his death, we will see that repeatability was not only a feature, but apparently a *precondition* of his chosen method of production. How was this done?

After looking at the concept and execution of these twin instruments and investigating the shop where they were built, I will attempt at least a suggestion as to how the viols might have been made.

Dimensions and Design

To begin a study of these twin viols, let us look at them first from the perspective of their design. This would be an anachronism if applied to many early English viols, as “design” in classical English work seems to have been an ad hoc procedure inseparable from execution. It makes sense in Bertrand’s case because, as we shall see, he intended his conception to be accurately realized more than once, indeed scores or possibly hundreds of times.

The most obvious feature of this design is its considerable size. The two viols discussed here, while by no means the largest extant viols in nominal D, are quite long, wide, and deep by any measure. The following list gives the principle measurements for the well-preserved 1720 New York Bertrand:

Belly length: 706 mm

String length: ~72 cm

Back upper bouts, max. width: 336 mm

Back middle bouts, min. width: 245 mm

Back lower bouts, max. width: 405 mm

Narrowest belly width between soundholes: 150 mm

Depth of sides (excluding plates) at fold: 133 mm

Depth of sides (excluding plates) at middle bouts: 135 mm

Depth of sides (excluding plates) at tail-pin: 135 mm

These dimensions can be seen as a mature solution to what would have been the central problem for any Parisian viol maker at the start of Bertrand's career: finding a good, workable design for the newly fashionable seven-string viol.

It is possible that Bertrand was the first to build seven-string viols of these imposing dimensions. It is also possible that he was influenced by his older contemporary Michel Collichon, who may have been his teacher.⁶ One Collichon viol, the "ex-Kessler," is strikingly similar in all dimensions to the Bertrand viol shown above.⁷ It is dated 1691, however—at least four years after Bertrand became an independent master. The four extant Collichon basses with earlier dates are all of smaller dimensions overall.⁸ Bertrand also built smaller bass viols, and the smallest is the earliest: the 1687 seven-string instrument now in the Muziek-instrumentenmuseum (MIM) in Brussels. This suggests that both Bertrand and Collichon began with smaller instruments and noticed improved tonal results with progressively larger and deeper viols. However arrived at, the dimensions of the two Bertrand viols in this study seem to lie near the upper limits of size, depth, and string length compatible with virtuoso playing, even for a large hand.

After deciding on basic dimensions, how did Bertrand develop the outline of the instrument and position its basic features? This question inevitably leads to the subject of instrument geometry—the idea that the maker generated a design from a rational ar-

⁶ Dietrich Kessler, "A Seven-String Bass Viol by Michael Colichon," *Chelys* 19 (1990): 55. Kessler notes, "It has been suggested that Colichon may have been the teacher of Nicolas Bertrand.... Although there are similarities in the style of their work, there are also marked differences." I note in passing that authentic labels in Michel Collichon's viols show two variant spellings of his last name (Collichon, Colichon). Following Muthesius, I have used the former spelling in this article, while Kessler used the latter after the label in the viol he described.

⁷ Kessler, "A Seven-String Bass Viol," 59.

⁸ Tilman Muthesius, "Michel Collichon, premier facteur de violes à sept cordes?" *Musique Images Instruments* 2 (1996): 51–52. These pages list comparative data for the eight known Collichon viols.

rangement of lines, circle sections, and other geometrical figures, using some numerical or proportional system.

This is a well-established idea in stringed-instrument literature but one that I think should be approached with great caution. It is not impossible, after all, that Bertrand simply drew a traditional shape without reference to any geometrical ideas whatsoever. There is evidence that this is exactly what some early English makers did. Fleming, for example, finds no evidence of consistent geometrical method in the group of early English instruments he studied. He also points out that the back/front and left/right asymmetries in those instruments, both built in and caused by later distortion, are enough to make certain types of geometrical analysis objectively unverifiable even if an underlying geometry did exist:

Even if precision is deliberately forsaken in order to maximise the apparent presence of certain proportions, the data from the viols examined for this study reveal no consistency in proportional relationships between major dimensions, and imply that standardisation and consistency were not features of pre-Restoration English viol-making....⁹

With Bertrand's viols, we are faced with a very different tradition, one perhaps of greater urban sophistication and intellectual ambition. His viols also seem to respond better to geometrical analysis than those in Fleming's study.

To be convincing, I think any geometrical analysis of instrument shapes must yield results that are both clearly verifiable and relatively obvious. The violin literature on instrument geometry tends toward an almost metaphysical complexity that, often, floats free of any concrete reality.¹⁰ In viol research, several writers have presented more down-to-earth analyses that seem more relevant to Bertrand's instruments.

⁹ Fleming, "Viol-Making in England," 50.

¹⁰ Simone F. Sacconi, *The "Secrets" of Stradivari*, trans. Andrew Dipper and Cristina Rivaroli (Cremona: Libreria del Convegno, 1979). Sacconi's well-known geometrical analysis of the Stradivari "G" form in Chapter 1 may serve as an example of "metaphysical" speculation. Although elaborately idealist, it does not fit the actual Stradivari form particularly well, and its theory depends on a selective conflation of the length of the form with the length of a hypothetical finished instrument.

Michael Heale, in a paper from 1986, seems to have been the first to suggest that basic geometric relationships govern the relative sizes of the parts of a viol.¹¹ While I find that most of his assertions, that twice the neck length equals the body length for example, hold true only in the very broadest sense, his paper suggests that a viol design can be meaningfully informed by proportional rules of thumb while allowing leeway in the execution.

In more recent work on English viols, opinions about the value of geometrical analysis have been divided. Kevin Coates has argued strongly for the validity of detailed geometrical analysis of viols,¹² while Fleming, as noted above, finds no evidence for geometrical design in many early English instruments. A recent paper by Benjamin Hebbert offers convincing geometrical constructions for both the structure and ornament of English viols by several makers.¹³

There seems to be less research on the geometry of French viols, but in a recent paper describing the restoration of an undated Nicolas Bertrand bass similar in size to the two discussed here, Charles Riché makes a number of interesting observations about its geometry.¹⁴ Because he did not publish full dimensions for the viol in question, it is not possible to determine how accurately he intended his description to be taken, but several of his observations fit the viols in this study quite well, while others do not.

Figure 5, based on the New York Bertrand, is indebted to ideas from all of these papers as well as a few of my own. It is not intended by any means to be an exhaustive geometrical theory of this viol's design, but only to establish that Bertrand almost certainly employed a coherent geometrical scheme. The geometrical shapes in the figure have been drawn precisely to the ratios described so that the reader can judge how well they fit the actual instrument.

¹¹ Michael Heale, "The Proportions of Bass Viols," *The Galpin Society Journal* 39 (Sept. 1986): 131–33.

¹² Kevin Coates, *Geometry, Proportion and the Art of Lutherie* (Oxford: Clarendon Press, 1985).

¹³ Hebbert, "The Geometry of Early English Viols," 6–14.

¹⁴ Charles Riché, "The Restoration of a Bass Viol by Nicolas Bertrand, Paris, Beginning of the 18th Century," in *A Viola da Gamba Miscellanea*, ed. Susan Orlando (Limoges: Pulim, 2005), 211–27.

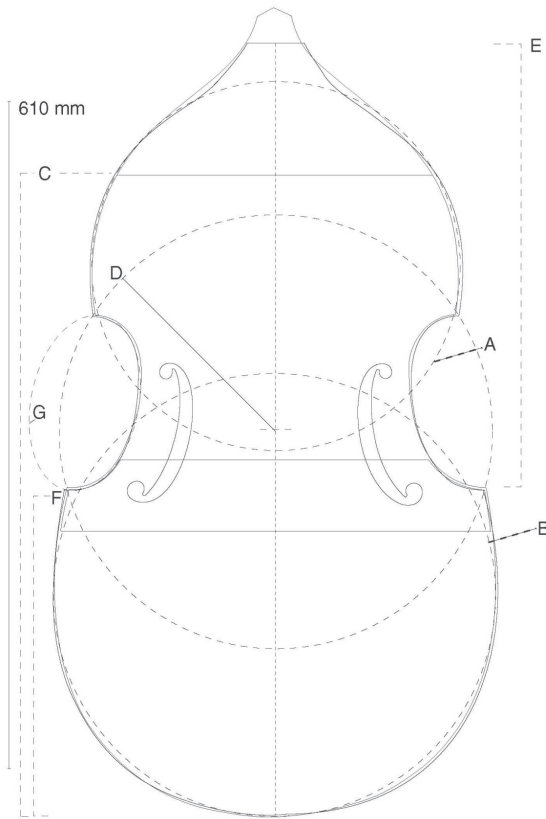

Figure 5. A composite outline of the New York Bertrand is shown with hypothetical geometry superimposed. The geometrical figures are drawn to exactly the proportions described, allowing comparison with the actual instrument outline.

A & B) Two circles in a ratio of 5:6, where the lower circle is $\frac{4}{7}$ of the belly length.

C) $\frac{5}{6}$ of the belly length compared to the fold position.

D) A circle drawn from the center (-2 mm) of the belly length intersecting all four corners.

E) The lower corners compared to $\frac{4}{7}$ of the belly length, i.e. the width of circle B.

F) The center of the soundpost plate compared to $\frac{5}{12}$ of the belly length.

G) An oval with two axes of symmetry such as can be drawn with two tacks, a pencil, and a loop of string.

The clearest feature of the design is that the top and bottom bouts fit quite nicely into, and are partially described by, two circles in a ratio of 6:5. This trait has also been observed in several English viols, and may have been a widely disseminated technique of viol design.¹⁵ These circles fit the top bouts well and help define but do not fully describe the more oval sections of the lower bouts. How did Bertrand arrive at these? It is possible to construct an elaborate system of tangent circle sections to fill out the outline, but it is likely that Bertrand, once he had established the cardinal points, drew the rest in some simple ad hoc way, perhaps merely bending and tracing a thin strip of wood. Once he had arrived at a traditional and pleasing curve, he could copy it to the other side.

The width of the lower circle is convincingly close to $\frac{4}{7}$ of the belly length, relating the instrument's width to its height. The fold also falls nicely at $\frac{5}{6}$ of the belly length. It is possible to draw a circle from the exact middle (-2 mm) of the belly length that neatly intersects all four corners of the middle bouts. It is also possible to do this with the corner blocks of many Cremonese violins, suggesting that this was another widely understood design technique. The radius of this circle is close to, but shy of, the circle defining the lower bouts. It is probably an ad hoc measurement since it defines the width at the lower corners. The distance from the belly top to a line drawn through the lower corners is very close to $\frac{4}{7}$ of the belly length, the same measure as the width of the lower bouts.

These observations seem fairly straightforward, but from here things become more speculative. For example, the center of the soundpost plate is quite close to $\frac{5}{12}$ of the belly length from the bottom. Is this a meaningful observation? Armed especially with digital tools, one can multiply these increasingly complex observations almost *ad infinitum*. What is unclear is whether they describe the thought processes of the designer. At some point in every geometrical analysis we start making assumptions about the significance of what we are seeing, with little basis for knowing what was significant to the original maker. At that point we have begun, mentally at least, to design the instrument ourselves.

In Bertrand's design process, considerations of playability might have sometimes trumped geometry. For example, the width

¹⁵ Hebbert, "The Geometry of Early English Viols," 12–13.

of the viol at the middle bouts needed to be sufficient for a bridge carrying seven strings, yet not so wide as to interfere with bowing the top and bottom strings at the desired bridge height. It is easy to imagine that he arrived at this sensitive measurement by experiment rather than geometrical theory. Traditional shapes may have also played a role, as suggested above for the shape of the lower bouts. Finally, there may be cases where we look for a complex solution to something that is quite simple. Descriptions of the middle bouts of bowed stringed instruments that depend on tangent circle sections tend to be alarmingly complex. Yet in many instruments, including the Bertrand viols examined here, the middle bouts conform very well to the ovals that can be drawn with the old carpenter's trick of using two tacks and a loop of string.

If Bertrand used a geometrical scheme to design aspects of the instruments in this study, did he use the same or similar schemes for instruments of different dimensions? Answering this question in detail is beyond the scope of this paper, but we can see very suggestive evidence for this by comparing the outline of his earliest extant instrument, the Brussels bass of 1687, with that of the 1720 New York bass. In Figure 6, the outline of the New York bass has been reduced by exactly 11:12 to correlate with the smaller Brussels bass. The two outlines can be seen to be quite congruent in the top and middle bouts while varying in the lower bouts. It seems obvious that they have at least some common elements of geometry and a fixed proportional relationship. This way of developing new designs out of pre-existing ones by keeping some curves while varying others is analogous to what Stewart Pollens has proposed for Antonio Stradivari's design process based on his analysis of the Stradivari molds.¹⁶

From the foregoing, it should be clear that there is in fact an underlying geometrical scheme of some sophistication in Bertrand's designs and that it probably contained elements that were widely shared among European makers of bowed stringed instruments. The *practical* significance of this design is considerable in that it allowed for a separation of the instrument's conception from its actual building. In late-seventeenth-century viol making this was

¹⁶ Stewart Pollens, *The Violin Forms of Antonio Stradivari* (London: Peter Biddulph, 1992), 14–16.

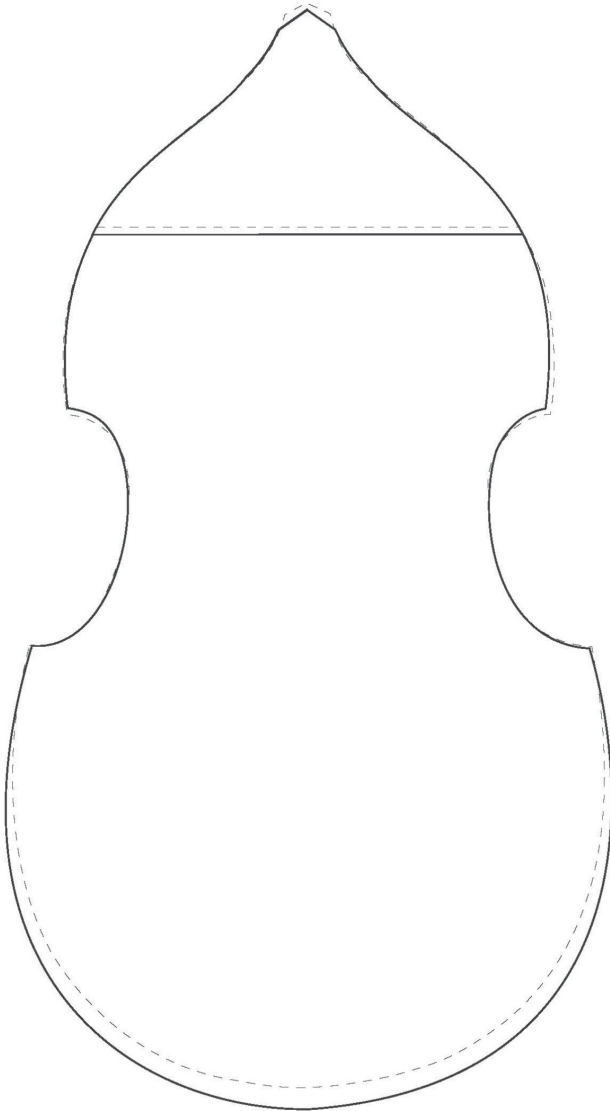

Figure 6. The outline of the New York Bertrand shown at 11:12 scale compared with the back outline of the 1687 Brussels Bertrand at full scale. The Brussels outline was digitally redrawn from a technical drawing by François Bodart, Muziek-instrumentenmuseum, Brussels. The outlines are quite congruent in the top and middle bouts, divergent in the lower bouts.

something of an innovation and, as we shall see, a necessary step for setting up the type of large-scale shop production that Bertrand wished to establish.

The Workshop

What do we know of Nicolas Bertrand and the workshop in which these twin instruments were created? His surviving labels, the earliest dated 1687 and the latest 1721, give us the approximate dates of his working life as an independent master and tell us that he spent his working life in Paris.¹⁷ In addition to these scanty clues, we have, thanks to what Frank Hubbard has called the French genius for red tape, a further rich source of information in the form of notarial documents.

The French Archives Nationales Minutier Central and the Archives de la Seine preserve at least eight documents concerning Nicolas Bertrand that give us a surprising amount of detail concerning his life and atelier. These were identified by Sylvette Milliot, who published a transcription of the most significant item—a full shop inventory—as part of her fascinating collection of documents pertaining to eighteenth-century Parisian luthiers.¹⁸

This inventory, dated November 10, 1725, was compiled on the occasion of Bertrand's death, which must have been only days or weeks before. It contains eighty-two line items covering hundreds of pieces of his property, including musical instruments, tools, materials, and other stock-in-trade. It was drawn up by the master luthiers Guillaume Barbey and Jean Vauboam, both viol makers from whom we have surviving instruments. These men were obviously knowledgeable about Bertrand's trade and, as may be inferred from some of their comments, seem to have been well acquainted with the master.

¹⁷The 1687 label is in the aforementioned bass viol owned by the Muziek-instrumentenmuseum in Brussels; the 1721 label is in a treble owned by the Musée de la musique in Paris.

¹⁸Sylvette Milliot, "Inventaire Après Décès de Nicolas Bertrand," in *Documents inédits sur les luthiers parisiens du XVIIIe siècle* (Paris: Société française de musicologie, 1970). See 127–31 for a diplomatic transcription of the parts of this document pertaining to the shop. Other sections of the inventory pertaining to movable property, silverware, clothing, etc., are briefly summarized.

The image of Bertrand that emerges from this document is hardly that of a humble craftsman at his bench, but rather of a prosperous bourgeois maker-dealer who kept on hand a vast stock of finished instruments, bows, strings, and cases, as well as enormous quantities of wood and semi-finished parts. It is worth noting in this context that Milliot cites Bertrand as being “*faiseur d’instruments ordinaire de la muzique du Roy*”—a considerable mark of professional success.¹⁹ There is no question that Bertrand’s shop was actively building viols. The very first item of the inventory gives pride of place to “nineteen [bass] viols with carved heads made by the said deceased.” But he also had a substantial business dealing in instruments made by other makers, and in supplying wood and parts to other tradesmen including makers of violins, guitars, and even harpsichords.

The inventory lists an astonishing 266 finished instruments on hand.²⁰ This total comprises 78 bass viols, 7 trebles, 34 pardessus and trebles,²¹ 91 violins, 9 bass violins, 5 cellos (*violons de chelles*), 6 guitars, and 36 pochettes (*poches*). It seems that Barbey and Vauboam stumbled across instruments in every room of the house. Four viols are specifically mentioned as being in the room in which Bertrand died, suggestive of how well they knew the deceased. Along with these instruments, Bertrand had in stock 129 bows, of which 34 were ivory mounted; 69 packages of strings; and a number of cases. The net value of these instruments, exclusive of bows and cases, was 3,507 livres, clearly a substantial sum.²²

Only a portion of these instruments were made in Bertrand’s shop. Those by outside workers include 20 “modern English

¹⁹ Milliot, *Documents inédits*, 21. Oddly, this title does not appear on any of Bertrand’s labels nor in the preamble to the inventory. Milliot does not cite the source of this information but it is presumably to be found in one of the notarial documents she examined.

²⁰ This total excludes 100 “old broken guitars” priced at 5 sols each, which probably constituted a sort of boneyard for wood or parts.

²¹ One item lists “15 pieces both pardessus and trebles with carved heads,” so the exact number of each is unknown.

²² Exactly how substantial is difficult to say. The livre, divided into 20 sous, was a currency of account. Twenty-four livres were sometimes considered the equivalent of the gold Louis d’or coin.

viols,” 42 violins by the maker Treuillot, 10 violins by the maker Dieulafait, 11 instruments described as “old,” and 23 as English. Clearly, any customer of Bertrand’s would have been able to suit his or her taste with some nicety.

More importantly for our purposes, the inventory itemizes a large stock of wood, semi-finished instrument parts, instruments in the white, tools, and benches. Some of this material—guitar backs, white violins, harpsichord soundboard wood and so forth—probably represented merchant activity. But if we focus on the items in the 1725 inventory that are specific to viol making, we learn about the scale and something of the manner of Bertrand’s production of viols. These are:

84 bellies for violins and viols, 25 livres, 4 sous
100 viol backs with their sides, 70 livres
9 finished viol bellies (*tables façonnées*) 5 livres, 8 sols
26 viol backs, 13 livres
10 viol bellies, 6 livres
A bundle of sides enough for making 4 viols, 2 livres
20 viol necks, 8 livres
10 necks with carved heads for pardessus, 7 livres, 10 sols
4 viol necks with scrolls, 2 livres
12 viol necks with heads, 24 livres
8 necks with scrolls for pardessus, 2 livres
8 pardessus all in the white (*toute blancs*), 32 livres

The inventory also includes over 600 viol pegs of various materials as well as the following tools:

2 rip saws, 15 livres
4 benches of solid wood with their fittings, 50 livres
4 iron planes of which 3 small and 1 large, 3 jointer planes and a jack plane, 2 scrub planes, and many other tools both of iron and wood proper for the said trade. 100 livres

This was a complex and apparently well-capitalized shop that was set up for the production of scores of instruments. The number of benches indicates that Bertrand employed additional workers,

probably two journeymen and an apprentice.²³ The tools in the inventory correspond largely to the *outils d'affutage* or heavy tools described in Roubo's *L'Art du menuisier* as being provided by the master to his workmen.²⁴ At this early date, Bertrand may have provided not just heavy tools but all the tools in use.²⁵

This busy picture immediately calls into doubt a most basic assumption, that the body of work signed by Nicolas Bertrand is the personal handiwork of that master. This may be an uncomfortable suggestion regarding a famous luthier, but in other branches of organology the facts of shop production have long been appreciated. Grant O'Brien has shown that the famous Ruckers workshops were large and complex operations where many workmen produced standard models from quasi-interchangeable parts.²⁶ Hubbard²⁷ and Hardouin²⁸ have shown a similar picture for Parisian harpsichord shops of the eighteenth century. In lute research, Sandro Pasqual cites a workshop inventory of the sixteenth-century lute maker Laux Maler, where parts and finished instruments

²³ Milliot, *Documents inédits*, 22. Milliot cites the maker Antoine Véron as the "garçon de boutique."

²⁴ André Jacob Roubo, *L'Art du menuisier* (Paris, 1769–74).

²⁵ Pierre J. Hardouin, "Harpsichord Making in Paris, Part I: Eighteenth Century," *The Galpin Society Journal* 10 (May 1957): 11. Hardouin translates the relevant passage in Roubo as follows: "By shop-tools, one understands all those tools which master menuisiers are obliged to furnish for their workmen, both those which are used in common and those which are provided to each man individually. Formerly they provided every possible kind of tool, but since the practice has been introduced of workmen performing their tasks on a piece-work basis, the workmen furnish themselves with all the necessary tools except the large ones called 'd'affutage,' such as the benches, jointing-planes, jack-planes, etc...."

²⁶ Grant O'Brien, *Ruckers: A Harpsichord and Virginal Building Tradition* (New York: Cambridge University Press, 1990).

²⁷ Frank Hubbard, *Three Centuries of Harpsichord Making* (Cambridge, MA: Harvard University Press, 1965). See Appendix C, "Inventories of the Workshops of French Harpsichord Makers....," 286–313.

²⁸ Hardouin, "Harpsichord Making in Paris, Part I," 10–29, and Parts II and III, *The Galpin Society Journal* 12 (May 1959): 73–85 and 13 (July 1960): 52–58.

were stocked in the thousands, clearly a sign of mass production by many hands.²⁹

Researchers of bowed stringed instruments have been slower to come to this view, in part because personal attributions are still so important for pricing in the violin market. Nonetheless, much recent work has stressed the importance of workshops and contract workers in producing instruments that were traditionally assigned to individuals. Roger Hargrave, in discussing the Amati workshop, stresses its methodical, businesslike approach and concludes, “Much of this work may have been carried out by the masters and their sons, but there can be no doubt that ancillary workers were also a fact of life.”³⁰

It is important to think about how collective production in a workshop is different from the work of an individual. In Bertrand’s case, we have no idea if he reserved for himself any particularly delicate operations—the cutting of soundholes, for example. But in a large shop that produced a uniform product, there was clearly a need for a *method* for building instruments that could be repeated by any workman. This in turn suggests that we should seek to explain the excellence of Bertrand’s instruments not in some intuitive manipulation of the materials by the master hand, but in the excellence of the conception and the enforcement of high standards.

The inventory also strongly suggests that Bertrand’s shop built instruments in *batches*. The item describing “9 finished viol bellies” is difficult to understand in any other light. There are other hints of groups of instruments of about that size: The 8 pardessus in the white, packet of sides for 4 viols, the various batches of 10 or 12 pre-carved heads. It does not seem improbable that different workmen would have been assigned to produce a required number of different parts in various stages of completion. We may see evidence for this in the marks of two completely different tooth

²⁹ Sandro Pasqual, “Laux Maler (c.1485–1552),” *Lute News: The Lute Society Magazine* 51 (September 1999): 6–7.

³⁰ Roger Hargrave, “The Amati Method,” originally written for the catalog to the *Retrospective Exhibition of Classical Cremonese Masters* (Cremona: 29 September–22 October, 2000), <http://www.roger-hargrave.de/Seiten/Bibliothek/Bibliothek.htm>.

planes found respectively on the sides and back of the Metropolitan Bertrand.

This picture of a four-man atelier also invites the question of how many instruments the workshop produced in a year. The answer must remain speculative, but one point of reference is the well-known account of Samuel Pepys's viol, built by a maker "... in Bishopsgate Street; his name is Wise, who is a pretty fellow at it" (July 16, 1663).³¹ The first reference in Pepys's diary appears on June 5, 1663 and concerns the head, which he is having made separately. On August 7 Pepys notes a visit he made to see "my Viall, which I find done and once varnished, and it will please me very well when it is quite varnished." The finished instrument is delivered on August 20, or about eleven weeks after the first diary entry.

Another picture is revealed by the Hill brothers' evaluation of Antonio Stradivari's rate of work, which they based on several sorts of data including the date of the mold for the Tuscan tenor and an inscription made sixteen days later inside an instrument made on that mold. Their conclusion was that Stradivari produced "one violoncello or two violins in a month."³² The Hills clearly ascribed to Stradivari alone what was the work of a large shop, so these accounts may be more or less in agreement.

If we assume that the Bertrand shop had something like Mr. Wise's rate of output per man, and that the apprentice spent much of his time delivering strings, sweeping the shop, and receiving customers, an output of twenty bass viols per year probably represents a reasonable guess. The output of smaller instruments would be somewhat greater. Thus, the nineteen viols in stock at Bertrand's death may have represented about a year's work.

From the stores of instruments on hand, it appears that the workshop did not usually make viols on a commissioned basis. Indeed, stock-in-trade rather than commission seems to have been

³¹ Samuel Pepys, *Diary of Samuel Pepys M.A., F.R.S.; Clerk of the Acts, etc.*, transcr. Mynors Bright, ed. Henry Wheatley (London: George Bell and Sons, 1904), 3:149ff.

³² W. Henry Hill, Arthur F. Hill, and Alfred E. Hill, *Antonio Stradivari: His Life and Work (1644–1737)* (London: William E. Hill & Sons, 1902; repr., New York: Dover, 1963), 224.

the normal pattern across Europe in the early eighteenth century. Hebbert considers Barak Norman (d. 1724) to be the last significant English viol maker who made bespoke instruments of variable size in the old way.³³ When Stradivari died in 1737, he left behind 91 standard instruments in stock.³⁴ The complementary nature of a stock-in-trade business with a standardization of the instruments themselves seems obvious.

The picture of Bertrand's shop we are thus able to resurrect from notarial documents shows a complex and ambitious establishment where instruments were produced on a large scale. This required the marshaling of capital, large quantities of materials, appropriate tools, and a method of construction that his hired workers could follow while the master did other things. One key piece of this picture would have been the specific tools needed to turn Bertrand's design into many near-identical instruments. Here, the documents offer no clues and the discussion becomes necessarily speculative.

Possible Form-Based Construction Techniques

Despite the many things we know about the construction of antique viols, there are still surprising gaps. This seems particularly true regarding the construction of the viol's sides—the element that determines, or at least must conform to, the shape of the finished instrument. Central here, with any school or maker, is the question of what if any forms, templates, drawings, geometric constructions, or other aids were used to give the instrument its shape.

In Bertrand's case, the problem is more narrowly defined but the solution far from obvious. We have seen that his shop was able to produce instruments according to his design to fairly close tolerances. There are strong indications that instruments were produced in batches, and that certain quantities of one part were finished independently of others. All of this implies the use of some sorts of templates. Yet we have seen from the internal construction that

³³ Hebbert, "The Geometry of Early English Viols," 3.

³⁴ Charles Beare, "Antonio Stradivari and his Contribution to Violin Making," in *Antonio Stradivari: The Cremona Exhibition of 1987* (London: J. & A. Beare, 1993), 27.

these were certainly not the usual inner forms of Cremonese violin construction.

What are the possibilities? On a purely speculative level, many techniques would have worked. The instrument sides may have been painstakingly bent to conform to a drawing. More likely, the back or belly might have been marked out from a template, cut to exact size, and then been used as a model for building the sides. There would be difficulties with this above the fold, where the back outline is narrower than the front, but nothing insurmountable if both back and front were accurately shaped beforehand.

Another possibility is that Bertrand's shop used some sort of form other than a Cremonese violin-style form. Sadly, beyond a few planes, no material from any eighteenth-century French luthier's shop seems to have survived, and nothing that might illuminate this question. The Bertrand inventory also makes no mention of forms. The only other relevant sources of information I am aware of are the three plates showing instrument makers' tools that illustrate the article "Lutherie" in Denis Diderot's *Encyclopédie*.³⁵ While most of these are either generic to woodworking or relate to violin making, three of the tools shown are specifically for viol making. Two of them seem to be forms for building viols.

It is important to remember that Diderot's *Encyclopédie* dates from over 40 years after Bertrand's death, and from a time in which Italian violin-making techniques were coming to dominate French lutherie. The accuracy of technical information in the *Encyclopédie* has also been questioned, in some cases with good reason. It is easy to point to examples of superficial observation or misplaced emphasis, and there seem to be cases where Diderot's informants deliberately lied about trade secrets. Hubbard, for example, cites the bizarre example of Plate XV in the "Lutherie" series that shows harpsichord bracing and ribbing that correspond to no known instrument.³⁶

³⁵ Denis Diderot and Jean le Rond d'Alembert, *L'Encyclopédie ou Dictionnaire raisonné des sciences, des arts et des métiers* (Paris 1751–65). The tools discussed here are shown in Plates XII and XIII, which illustrate the article "Lutherie." These are found in the *Recueil De Planches*, Volume 4, dated 1767.

³⁶ Hubbard, "Three Centuries of Harpsichord Making," 213. See also Hubbard's plate XXXV.

Nonetheless, the illustrations of luthiers' tools (Diderot's plates XII, XIII, XVIII; this article Figures 7 and 8 reproduce the first two of these) show careful observation and, where we have a point of comparison, are very accurately drawn. Some, like the three small arching planes (article Figure 7), are uncannily like the tools we use today. Others are unfamiliar but functional and make for fascinating study. The *Creusoir*, hollower (Plate XIII, fig. 34; see Figure 8 for this and the following tools), a block for holding violin plates during hollowing out, could be profitably adapted by any modern maker. Other tools, such as the *Compas d'épaisseur*, thicknessing compass (fig. 35), the *emporte-pieces pour les ouies*, punches for the soundhole eyes (fig. 45, 46), or the *filiere*, a tool for drawing purfling strips to thickness (fig. 48–52), offer a fascinating insight into eighteenth-century French shop practice.

Some of these tools are for general use, while others are clearly specific to violin-family instruments. Only three items in Plate XII—figures 14 and 15 (*Fausses tables*, “false tables”) and the self-explanatory figure 17 (*Patron pour les ouies des dessus de viole*, “pattern for the soundholes of the treble viols”)—are identifiable as being proper to viol construction. Nonetheless, they seem to give us our only glimpse of native French viol makers' tools.

The first and perhaps most important of these is the viol-shaped “false table” shown in figure 14. We notice immediately that this tool is angled at the top in a way that corresponds to the sloped shoulders of a viol. The corners of this form are oddly violin-like, but we find exactly the same strange corners in Diderot's illustration of the bass viol itself.³⁷ We are probably safe in considering this to be a quirk of the engraver and that we are being shown the corners of a conventionally shaped viol.³⁸

How large is this false table? The plate has no scale, and some objects like the thumb plane are obviously shown enlarged. But the violin and cello forms at the top of the page seem roughly in the 1:2 ratio we would expect, and the viol forms are shown at about

³⁷ Diderot, “Lutherie,” *Recueil De Planches*, Plate XI, fig. 1, labeled “Basse de viole.”

³⁸ It is also possible that Diderot's illustrations show both a viol and a viol form with violin corners. This seems unlikely at this late date in France, but is not out of the question.

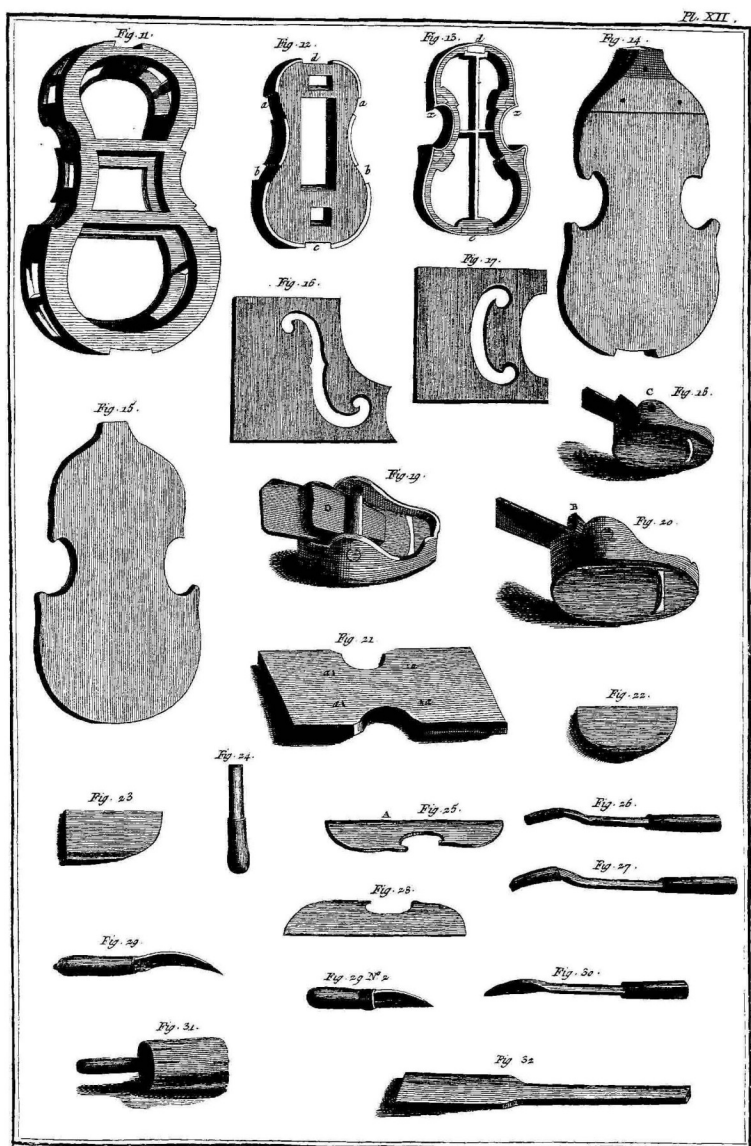

Lutherie, outils propres à la Fabrication des Instruments à Archet.

Figure 7. Plate XII illustrating the article “Lutherie” in Diderot’s *Encyclopédie*. “Tools for the manufacture of bowed instruments.” Diderot’s figures 14, 15, and 17 are viol makers’ tools. The volume of plates is dated 1767.

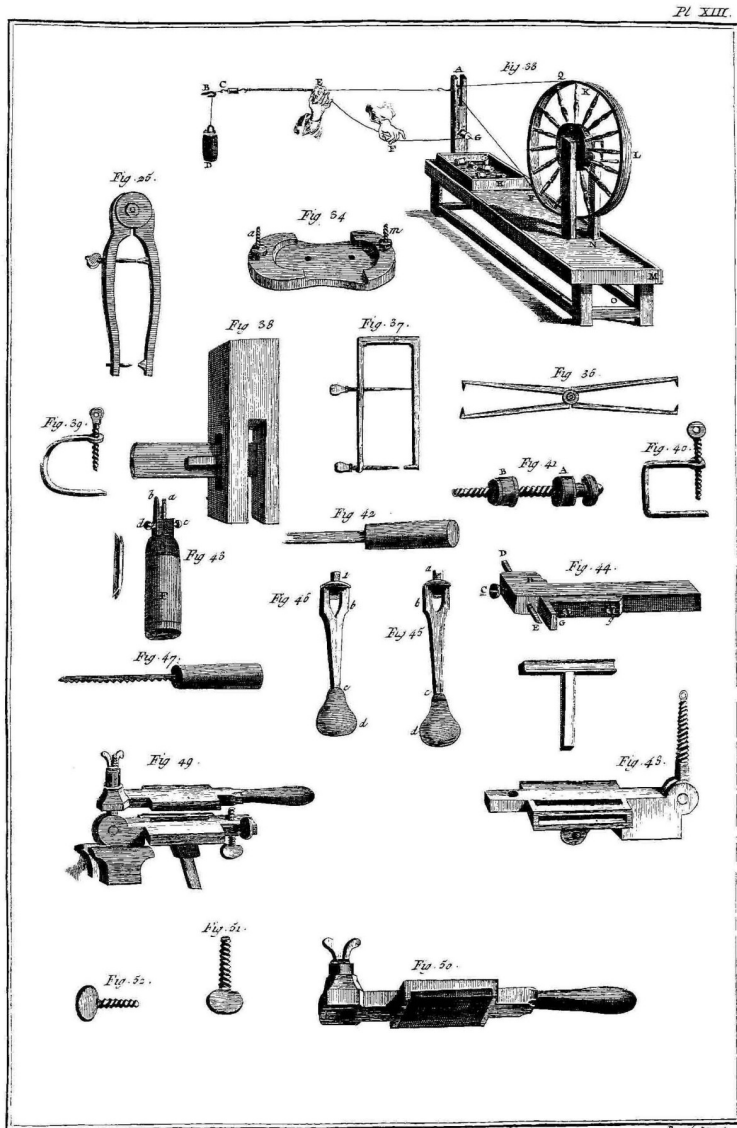

Lutherie, suite des outils propres à la facture des Instruments à archet

Figure 8. Plate XIII illustrating the article “Lutherie” in Diderot’s *Encyclopédie*. “Tools for the manufacture of bowed instruments, continued.” For the most part, the tools seem well observed and accurately drawn.

the same size as the cello forms. If we accept that all the forms are drawn to the same scale, we are dealing with a form for a large bass viol.

What was this tool used for? It has sometimes been interpreted as a simple clamping jig, to be used when gluing the angled back of the viol to the sides. Adolf König, for example, shows such a tool used in this way.³⁹ For such a straightforward task, this complex instrument-shaped tool would not only seem to be overkill, but cumbersome and time-consuming to make.

Another possible interpretation is that this is a template on top of which the back and sides of the viol are assembled, with the angled portion used to support the folded back. The viol maker Shem Mackey has published an elegant way to build an instrument with the characteristics of a French classical viol using a tool of exactly this type.⁴⁰

I would find this entirely convincing were it not for an additional problem: The tool illustrated has a cutout on its lower end to receive a bottom block. This strongly suggests that this is an inner form of some sort, to which the bottom block would be provisionally attached and around which the sides would be assembled. A further detail, the three round spots on the shoulder area of the tool, supports this interpretation. What our modern eyes might see as reinforcing screws appear to be holes. Such holes could certainly be used for a stick-and-caul clamping system of the sort used on Cremonese violin molds,⁴¹ and these would necessarily have pressed the sides *against* the mold. Any viol maker knows that this is precisely the place where some ingenious clamping help is needed.

Arguably, the cutout might simply be an engraver's error, a feature borrowed from one of the violin forms. But this isolated bor-

³⁹ Adolf H. König, *Die Viola da Gamba* (Frankfurt: Edition Bochinsky, 1985), 138.

⁴⁰ Shem Mackey, "Viol Making Without a Mould," *The Strad*, vol. 118 no. 1403 (March 2007): 72–75.

⁴¹ Sacconi, *The "Secrets" of Stradivari*. See chapter 2 for the classic account of the Cremonese mold and its stick-and-caul clamping system. This ingenious way of clamping the sides of the violin to the interior blocks during gluing operations was developed because early violin makers had few iron screw clamps.

rowing seems a strange error to make. Given the overall accuracy of the other illustrations, I think it more likely that this shows a viol makers' tool that actually existed, and I attempt to interpret it as such.

Although similar in concept to the violin mold shown on the same plate, the false table, interpreted thus, is different in that it has no provision for corner blocks nor, apparently, a top block. How might such a form have been used? And could it or something like it have been used to build Bertrand's instruments? I will suggest a method to show that this is possible, but in the discussion that follows, it is important to remember that the engraving is not a photograph, and that from the present evidence several interpretations are possible.

Unlike Diderot's violin form, which seems as thick as the full height of the violin's sides, a form of the type shown in his figure 14 would lie flat on the bench and touch only the bottom outline of the instrument. Building the garland of sides on such a form would present few problems, at least below the fold. The workman in Bertrand's shop would have begun by lightly gluing a shaped bottom block to the form. Then he could begin the sides, bending his wood to fit snugly around the form. The outline in the middle bouts would define the width of the instrument and provide a template for the most difficult part of the bending. It is unclear how the corner miters were glued on Bertrand's viols (on any antique viols for that matter), but this could have been done using the form to check the shape. The maker would also permanently glue the lower bouts to the bottom block, probably using some sort of counterblock and clamps to compress the joint.

Above the fold the situation is somewhat more complex, because the angled part of the false table would touch not the actual shoulders of the viol but the waste wood that is cut away to create the angle for the fold (see Figure 9). This interpretation also requires that the sides would have been glued to the through-neck while the form was still in place.

I imagine that the maker would have begun this section of the viol by preparing the complex gluing surfaces on the neck that would receive the sides and back. Here the form could be used to define the precise heel angle (see Figure 10). Note that the side an-



Figure 9. The shoulder portion of a viol form built according to the interpretation of Diderot's *false table* presented in this paper. The pencil line shows how the angle of the fold begins at the bottom of the form and extends to the surface of the wedge. The sides below the pencil line will later be cut away to create the angle of the fold.

gles of the neck would simply have been extensions of the side angles at the top of the form. Next, the maker would have bent the shoulders to fit the form and the sides of the neck. Finally, he would glue the sides to the neck using cauls, sticks, and twine to clamp the joint, pressing the sides against the neck. During gluing, the pegbox would simply have rested on the bench supporting the (substantial) weight of the uncut neck.⁴² The angled heel would have rested on the form.

At this stage, the sides would be complete, the neck and bottom block would be permanently glued to the sides, and the form still in place (see Figure 11). Throughout, the maker would have needed to use waste paper, tallow, or something similar to ensure that the sides did not actually glue themselves to the form.

It would be logical at this point for the maker to slip the dimensioned back under this assembly and trace the outline of the

⁴² The pegbox of the New York Bertrand almost touches a flat surface when the viol is placed on its back.

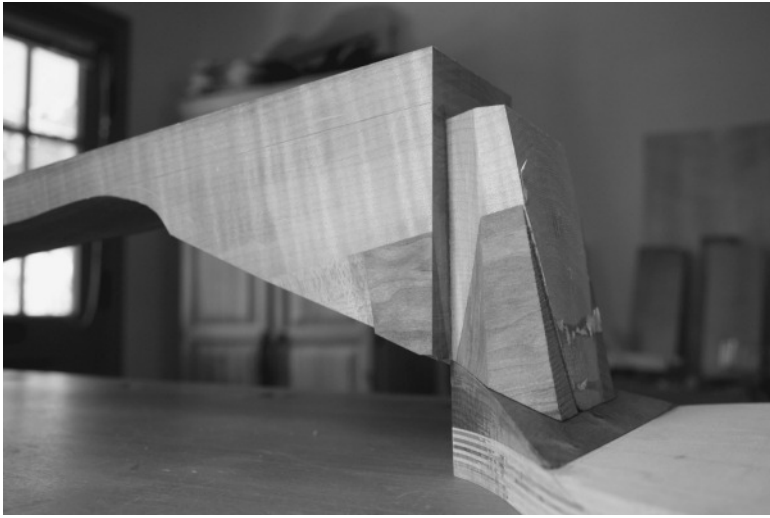

Figure 10. The form is shown with the uncut through-neck resting in position. Note that the angle on the wedge portion of the form is used to create the precise angle on the heel of the neck. The angle of the neck to the body is defined by the pegbox (not shown) resting on the bench. The taper of the sides of the neck is a continuation of the taper of the wedge portion of the form. The sides will be glued into the cutouts made in the side of the neck. (The darker sections of wood near the heel are extensions used to widen the neck block; modern luthiers' wood is much narrower than the enormous neck blocks of Bertrand's time. These extensions will not be visible on the outside of the finished instrument.)

viol from the finished sides. He would then remove the back, trim it almost to the traced outline, and cut and bend the fold. It would also make sense to trace the shoulder angle, as defined by the angled top of the form, onto the *inside* of the shoulders.

Now, the form would have to be pulled out from the bottom of the garland of sides. Since the shoulder is somewhat smaller on the back outline than on the front, this would require loosening the bottom block first and angling the form downwards, then out. This sleight of hand is analogous to the removal of violin sides from a form with both sets of liners glued in place, something that the Cremonese makers seem to have done routinely.⁴³

⁴³ Roger Hargrave, "The Method of Construction Used by the Cremonese Makers Circa 1550–1750," *Journal of the Violin Society of America*, vol. 10 no. 1

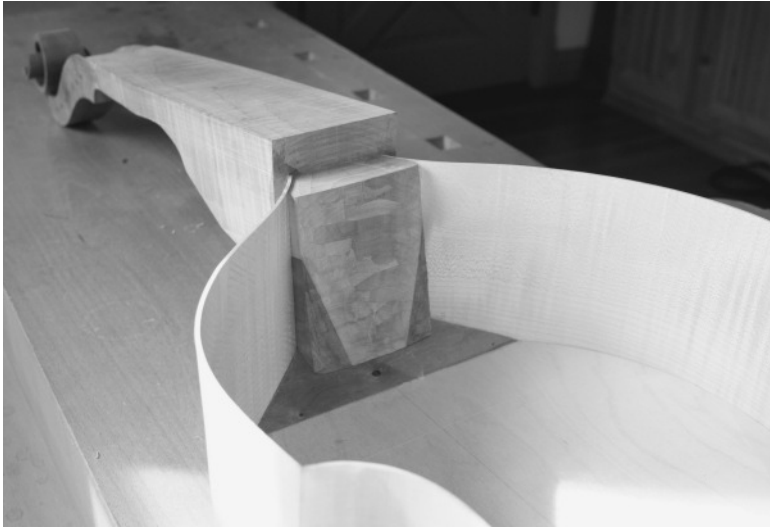

Figure 11. The completed sides glued to the through-neck. At this stage, the sides and neck joint are finished and an outline can be traced onto the prepared back before the form is removed from underneath.

Now, the maker would simply need to trim the waste wood of the sides at the shoulders up to the scribed line and perhaps touch up the heel joint with a plane. He could then begin gluing the back to the sides using the scribed outline on the back as a guide. The gluing of the back to the heel is always a tricky operation, since the neck must be set on straight and the sides and neck are quite flexible until the back is firmly attached. Here, the positioning pin found in the heel of Bertrand viols could have provided both an anchor and a pivot point for swiveling the neck until correct. This would also explain the lack of a positioning pin in the lower back: it was unneeded since the sides would already have been firmly glued to the bottom block.

What role did Diderot's figure 15, the other "false table," play here? This could have been a template for marking out bellies, or it may have been used to control the top outline of the sides since this

(1989): 33–108. Hargrave deduces this from cut marks made during the trimming of the liners that are found on both the tops and bottoms of the original Stradivari forms. Although improbable sounding, it is in fact straightforward to remove a violin form with all liners in place.

is different from the bottom outline. It may also have been used when gluing the back to the sides, to spread the pressure of the maker's few clamps. Because it does not have a cutout for a bottom block, it could not have fit inside the sides.

This discussion is speculative, but a viol built in this manner would have the characteristics of the twin viols examined here: overall regularity and symmetry, a traditional look in the interior, and some slight irregularities such as the non-vertical sides or minor deviations in the outline. In the workshop, such a form could have been used to assemble necks, sides, and backs to a predetermined shape, while bellies with their soundholes and bassbars could have been built separately to fairly close tolerances. While my own shop practice does not constitute any sort of historical proof, I have copied a Bertrand bass viol using a form of exactly the sort described above and can state that it is both a practicable and convenient working method.

Conclusions and Future Research

The broad conclusions of this study, that the workshop of Nicolas Bertrand built standardized instruments in large numbers using a rationalized, form-based system of construction and employing many hands, may not be particularly edifying to lovers of fine stringed instruments. It suggests that the whole business was far less artistic or inspired, indeed far more of a business, than our usual conception would have it.

To counter this, I would point to the instruments themselves, as they are so obviously well conceived, elegantly built, and musically successful. After Bertrand's death, his instruments continued to appear in inventories of later Parisian viol makers until changes in musical taste finally extinguished the French viol altogether. In the nineteenth century they achieved an afterlife either as cellos or as artifacts for collectors, sometimes traveling under Cremonese colors. Today they are highly coveted, to say the least, and no one who has heard a Bertrand viol in good playing order can doubt his accomplishment. Who would object to a Ruckers harpsichord because it was made in a big shop? If this seems problematic with stringed instruments, perhaps it is time to reassess our assumptions.

This study also suggests an obvious question: Do these twins have other siblings? It should be clear that a list of measurements from any particular viol cannot answer the question, since slight variations in dimensions (and certainly changes due to later repairs) can obscure an identity that is only obvious with carefully drawn outlines. But among the sixteen extant Bertrand viols, measurements alone suggest several obvious candidates for membership in this family. I would appreciate any opportunity that either institutions or private owners might be willing to provide to investigate this question further.

This study also suggests that there might be other identifiable “models”—other sets of matching Bertrand viols. Finally, it does not seem out of the question that other Parisian makers used a similar system, especially as the eighteenth century wore on. It might be possible to document the transmission of design concepts, models, possibly even of molds themselves, by continuing to document the outlines of as many French viols as possible.

Bertrand’s career comes at a period of great change in the history of the viol, with makers in both France and England moving from bent stave to two-piece top construction, and from ad hoc making to the use of forms with their implication of an a priori design. They were also moving from an older system of bespoke instruments to a business based on stock-in-trade. It has been well beyond the scope of the paper to investigate the driving forces behind these changes, whether musical, technical, commercial, or the result of shifting national influences and fashions. What is clear is that Bertrand embraced these changes and, in early-eighteenth-century Paris, may well have been their leading exponent. That he and his workmen were able to seize on these new possibilities to produce instruments of such consistently high quality is a testament to his vision and skill.

Appendix I: Description of the Viols

Bass de Viole by Nicolas Bertrand (Paris, 1720), Metropolitan Museum of Art, New York

The Metropolitan Museum's Bertrand viol is arguably one of the best-preserved Bertrand basses in existence. It retains all its original parts except for its pegs, nut, and bridge. At first glance, this might not be obvious, as the instrument presents a somewhat dilapidated appearance. The top shows considerable old damage, the original varnish is (thankfully) unpolished, and the original neck has been drastically narrowed.

The undisturbed manuscript label, in ink on parchment and written in simple but elegant calligraphy, reads "Nicolas Bertrand / a Paris 1720." The back at the heel of the neck is branded "BERTRAND."

According to museum lore, the instrument was originally discovered in the cellar of a convent-hospital in Quebec and passed through several hands before acquisition in the 1930s.⁴⁴ At some early date, the neck of the Metropolitan's instrument had been roughly cut down to cello width and presumably strung with four strings. Oddly, one other Bertrand viol, a heavily restored bass now owned by the Université de Montréal, seems to have come out of the same cellar and to have been similarly converted, suggesting that the cutting of both necks happened before these instruments were dumped in the *caveau*.⁴⁵

The neck of the Met's viol was later widened in a somewhat more professional manner by the addition of slats on either side of what remained of the original neck core. Several fairly crude interior repairs including guitar-style top liners probably date from the same time. This work seems to have been done before acquisition by the museum. Otherwise, the instrument remains in largely original condition. The head and pegbox are unaltered; the string length is about 71–72.5 cm depending on bridge location.

The top of the viol is made of two matched pieces of conifer wood, probably spruce, with pronounced and relatively wide reed lines. It gives every appearance of having been carved out in the

⁴⁴ Conversation with the Associate Curator, April 2006.

⁴⁵ MacCracken, Viol List database.

traditional violin manner. Bertrand seems to have used two-piece construction in all his viols, including the earliest surviving example from 1687. This is a very different approach from the elder Collichon's bent-stave tops, and Bertrand may have been the first French maker to adopt it.

Surprisingly, Bertrand's two-piece construction did not seem to have led to much greater top thicknesses than those found in Collichon's viols. Tilman Muthesius reports top thickness between 2.5 mm and 4 mm for the Paris Collichon, for example.⁴⁶ The New York Bertrand has an overall thickness of about 3.7 mm, with some spots as thin as 3.2 mm. While some of these thin spots lie near the edge, other edge areas are of full thickness and I do not see evidence of an intentionally thinned edge. Rather, the impression is that Bertrand aimed for a thickness of about 3.7 overall but did not consider variations to be problematic.

Old damage to the top has somewhat distorted the arching shape, but enough remains to see the sophisticated conception. The longitudinal arch presents an even rise and fall from top block to bottom block without a noticeable plateau in the center. The transverse arches fall smoothly in a positive curve from the center line to a point about 2–3 cm from the edge. From here, they rise slightly to the fairly square edges in a broad and almost imperceptibly shallow scoop that was probably executed with a light scraping only. This scoop is more pronounced along the wings of the soundholes, where the negative curve runs right to the edge of the wings. The beautifully cut soundholes, made in the traditional "C" pattern, have a distinctive roundness to all their curves and attenuate in graceful points. On the interior, they are beveled in the usual way to leave standing edges about 1.5 mm thick.

The belly is inlaid with a single strip of black/white/black purfling set about 3.5 mm from the edge and is otherwise unornamented. A positioning pin passes through the belly into the bottom block. The overall visual impression of the belly is one of careful execution and restrained elegance.

The back of the instrument is made of two matched pieces of quartered maple with a narrow pronounced curl running at right angles to the center join. The year rings themselves run straight.

⁴⁶ Muthesius, "Michel Collichon," 44.

The thickness of the back tapers, possibly deliberately, from about 4.5 mm near the bottom block, to about 4.0 in the region of the soundpost plate, to about 3.8 mm in the shoulders. The edges, flush with the sides, are left fairly square. There is no inlay nor other ornament on the back. A single positioning pin is located just above the brand stamp and runs into the heel of the neck. There is no pin at the lower block.

The sides are of a more broadly flamed maple cut on the slab. The lower bouts are about 2.1–2.4 mm thick, the CC's and shoulders 1.6–1.8 mm. It is distinctly noticeable that the sides are rarely at right angles to the ground plane of the instrument but randomly deviate from the vertical by up to several millimeters. Likewise, the corner miters are frequently bowed rather than straight. It is difficult to tell how much of this is due to almost three centuries of warps and strains, but I get the impression that some of this was present when the instrument was new.

The original tailpin, 14.7 mm square in section at the top, is made from a blond wood, probably maple, varnished black. It tapers in all dimensions towards the bottom. Above the hook, all four sides are simply rounded off towards the apex. It was clearly inserted from the top and butts against the back at the bottom of its fairly shallow channel.

The neck is the only part of the viol that has been heavily altered, and the history is somewhat speculative. In its original state, the unfigured hardwood neck (sorbus?) was fitted with an oak-cored fingerboard veneered with a black or stained exotic hardwood. It may have been as wide as 66 mm at the top and would have been quite thin in section.

The cutting of the neck to cello width must have been part of an extremely perfunctory conversion, as indicated by the presence of the original seven-string tailpiece and unaltered pegbox. In this state, the original neck and veneered fingerboard, drastically narrowed, still had their original length. In the next stage, as part of a larger repair, wings were glued to the sides and bottom of the neck and, separately, to the fingerboard, to widen both. In the resulting hodge-podge, it is still possible to see a center strip of the original oak fingerboard core and, on the fingerboard top, a strip of the original veneer. The top radius of the fingerboard has been altered,

and the neck is still far too narrow. The fingerboard length of 486 mm and neck length of 326 mm are probably both original.

The current fingerboard projection is about 70 mm at an average bridge position, implying a bridge height of about 8 cm. This is not impossibly low, but I suspect that the fingerboard may have sunk somewhat while the instrument was being repaired with the top off. It is interesting that the back of the pegbox comes within about 1 cm of touching a flat surface when the viol is placed on its back—in other words, that the viol back and the back of the pegbox lie almost in the same plane. If the neck was originally tipped a little further back, it would have touched exactly, and this may have been a handy aid during construction, as suggested above. This hypothetical tipping would imply a bridge height of about 9 cm, a measurement that practice has shown is more advantageous for comfortable bowing of the outer strings on a viol with middle bouts of this substantial width.

The finial shows a smiling, dimple-chinned young woman with long curved tresses partially covered by a trifoliate diadem or helmet. Bertrand seems to have used several carvers for his instruments, and this head, while attractive, is perhaps not among the finest. On the back of the elegantly curved pegbox, a small floral ornament extends just below the top peg. Otherwise, the pegbox is completely plain. The walls of the pegbox are quite thick, 7.8 mm on the upper edge near the well-cut scallops thickening to about 10 mm at the throat. The seven peg holes have never been bushed and show almost no wear. The diameter of the hole for the low A peg is about 10 mm.

The original tailpiece has the same oak core and exotic veneer as the original portion of the fingerboard. At 298 mm, it is quite long. The top width is 88 mm wide tapering to 42 mm at the base. The string holes lie on a scribed line 12 mm from the top edge. The top radius at the string holes is fairly flat, about 125 mm. The top veneer curves fully over the long edges, which would have given the impression that the tailpiece was made of solid ebony with rounded sides.

The varnish is very well preserved on large parts of the instrument and it appears to have almost no overpolish. It shows a distinctive pattern of lines and craquelure, and a tendency to clump

into tiny islands, especially on the head where it was thickly laid on. Under black light, one might mistake its milky opalescence for that of a classical Italian violin. This is almost certainly a cooked oil varnish. The presence in Bertrand's shop of "a machine, wooden, [with] chains and cords, which serves for suspending varnished instruments for drying them"⁴⁷ would tend to confirm this, as such a machine would be completely unnecessary for spirit-varnished instruments, which dry instantly. Certainly, Bertrand's varnish is utterly different in color and texture from the pale red-orange seedlac varnishes that became fashionable on Parisian viols and violins by the mid-eighteenth century.

On the back, where the instrument has been protected from light, the varnish top coat is still a beautiful deep red. An undercoat below the red layer is so distinctly yellow that it may have been deliberately pigmented in imitation of older Italian varnishes. The sides and front are much browner in tone; apparently, Bertrand's red pigment was not lightfast. The belly especially is very dark and may have been deliberately shaded at some point to hide its considerable damage.

Perhaps Bertrand was attempting—very successfully—to emulate highly colored varnishes he had seen on Italian instruments. In this context, his use of a two-piece carved front, handsomely figured maple for sides and back, and very restrained decoration might also be seen as modern, Italianizing traits.

The interior of this viol is in almost pristine condition and makes an extremely conservative impression. Bertrand's use of tools was certainly deft, but he made no attempt to remove tooth plane or other tool marks or pretty up the inside of the instrument in any way. Bertrand dimensioned the figured wood of the sides and back using a deeply toothed plane run at about a 45-degree angle to the grain of the wood. The back and sides appear to have been planed with two different planes, as the tooth marks are pitched quite differently. The joint between back and sides, and the center joint of the back, are reinforced only with parchment

⁴⁷ Milliot, *Documents inédits*, 25. This quotation is drawn from AN Minutier Central XXXIX, 329, 10 Décembre 1725, which records the sale of Bertrand's shop to his successor Claude Boivin. This obviously intriguing document remains unpublished except for a few excerpts.

strips. The corners of the middle bouts are mitered and likewise reinforced with parchment. Bertrand pressed these reinforcing strips and even his label so firmly onto the wood that the marks of the tooth plane are visible on the parchment surface. The fold is reinforced on the inside with five small conifer blocks fitted and glued to the inside angle. There are no other interior braces.

The joint between the belly and sides is currently reinforced with guitar-style liners that almost certainly date from the quasi-restoration of the neck. It is difficult to tell if Bertrand used any sort of top liner (parchment could not be applied because the instrument would have been closed). Parchment reinforcements cut to fit around the soundholes may be original.

The soundpost plate of quartered conifer is 65 mm wide, about 6 mm thick, and has the usual cross-grain orientation. Its lower edge sits 38 mm below the lower corners of the middle bouts as seen from the inside. If we accept that the soundpost would have been set up in the middle of the soundpost plate, the bridge position would be quite low, approximately on a line connecting the tops of the two lower soundhole eyes. The soundpost plate is lightly beveled on its two long edges and appears to butt right up to the sides of the instrument, to which it is secured with linen. It is pleasing to see that Bertrand had no qualms whatsoever about gluing the soundpost plate to the deeply toothmarked back, a joint more air than glue that might give a modern maker pause.

As mentioned above, there is no separate top block. The foot of the neck extends several centimeters into the body and provides gluing surfaces for the sides, back, and belly. The gluing surface for the sides is relatively narrow, about 2 cm. The visible glue joints where the sides butt up against the neck are quite clean, indicating that this somewhat demanding aspect of through-neck construction was carefully executed.

Bass de Viole by Nicolas Bertrand (Paris, undated), Caldwell Collection, Oberlin, Ohio

The undated Oberlin Bertrand is so similar to the New York instrument that much of the description above applies to it as well. It has undergone more alteration, however. The belly, garland of sides, and the back with its fold reinforcements remain from the original, while all other parts have been replaced.

Inside the instrument, we find a printed repair label of Gibertini Di Parma, a minor nineteenth-century Italian violin maker who seems to have been responsible for most of the changes to the instrument. We also find a manifestly fake label of “Carlo Bergonzzi” [*sic*], whose presence gives an indication as to why the changes were made.⁴⁸

Both of these labels are glued to a thick and clearly non-original sound-post plate. The wood of this plate matches the wood of four large corner blocks, a set of broad top and bottom liners, and large top and bottom blocks, all also non-original.

The interior back and sides of the instrument have been scraped clean of tooth-plane marks, although a few faint traces remain to show kinship with other Bertrand instruments. A small section of the back at the heel of the neck, which would have been stamped with Bertrand’s brand mark, has been replaced with a blank piece of maple. These changes would have required a near-complete disassembly of the instrument. The presence of Gibertini’s label on top of the new work almost certainly identifies him as the party responsible.

The viol’s rather thick neck, fingerboard, seven-string pegbox, and massive but well-cut scroll with foliate carving also appear to be by Gibertini. The lower back of the pegbox is mortised to expose the tuning heads of twelve tiny metal machine tuners. These once carried twelve metal strings that passed through a hollow in the fingerboard, across the belly to the bridge, and then over a tall saddle at the bottom of the instrument where they were finally attached to twelve small hitchpins in the lower bouts. The ebony fingerboard still shows filled channels where fixed frets had been inserted. Both the fingerboard and the matching fluted tailpiece are decorated in Empire style with handsome satinwood inlays. The non-original tailpin, made of the same boxwood (?) as the saddle for the sympathetic strings, is tapped for a threaded endpin.

⁴⁸ The full text of the repair label reads: “Restauro e coresse nell Anno 1838 in Genova / ANTONIO GIBERTINI DI PARMA / Premi[at]o piu volte in Milano con Medaglio, etc.” (“38” and “Genova” are handwritten. “Premiato” is partially erased). The full text of the fake Bergonzi label is: “Carlo Bergonzzi fecit. / Cremona 1727” (“27” is handwritten).

This hybrid instrument was probably meant to be taken as a *lyra viol*. The conversion work was skillfully executed and the instrument was certainly playable in its new state. Still, it is hard to see a motive to these changes other than fraud—the conversion of a Bertrand into a Bergonzi. I suspect that the instrument was intended for sale to a collector rather than a musician, because it was not converted into a cello. We can be thankful, as this would have caused far worse damage to the viol.

At a later point in its history the instrument passed through the Dolmetsch workshop, and it still retains a seven-string bridge stamped ARNOLD DOLMETSCH. This bridge has no provision for carrying sympathetic strings, so it seems likely that Dolmetsch had removed them. It is possible but unlikely that some of the fittings described above might be attributable to Dolmetsch. They do not appear typical of his work, however.

In modern times, Peter Tourin has added an extension to the top of the fingerboard, making the instrument playable as a seven-string viol with something like the original string length. Despite these many changes, this instrument retains the characteristic and beautiful sound known from the handful of other playable Bertrand viols.

In some ways, the exterior of this viol tells more about Bertrand's workmanship than the reworked interior. The two-piece belly is made of conifer wood quite similar to that in the New York instrument but with more variable and more widely spaced year rings. In places near the bass foot of the bridge, the year lines become quite irregular and we find several original wood patches under the varnish that were used to plug knots or resin pockets. The belly is currently 69 cm in length but has clearly been truncated at the top by about 1.5 cm. This can be seen by the fact that the neck/body join is not at right angles to the plane of the back but is strongly angled forward (i.e., toward the bottom of the instrument) by that amount. It may be that some wood from the upper edge of the sides was destroyed when the original through-neck was removed and that this expedient hid the damage.

The back is made from two matched and strikingly figured pieces of maple. The narrow and intense flames point upwards at the shoulders but change their angle around the lower third of the

instrument so that they come to point downwards in the area of the tailpin. The wide year rings of the back run in an oval rather than in straight lines and meet to form a beautiful lenticular pattern at the center joint. The back edges are generally about 3.0 mm thick and the back itself about 3.5 mm overall. The visual impression is much wilder than that of the New York Bertrand.

The sides, of slab-cut maple with a more regular figure, are about 130 mm high at the center bouts to about 132 mm near the tailpin. They may have originally been as high as the Metropolitan Bertrand (135 mm) and subsequently planed down by Gibertini in the process of cleaning up his new liners. The sides at the lower bouts are about 2.5 mm thick, the center bouts and shoulders about 2.0 mm to 1.8 mm. In several lovely spots on the lower bouts, we can see faint marks of a tooth plane on the *outside* of the instrument, underneath the varnish. As on most stringed instruments, the varnish has been polished over and over during its life and is somewhat retouched in places. Nonetheless, it still shows its distinctive color and texture, and in places we see craquelure similar to that of the New York instrument.

Appendix II: About the Illustrations

Michael Fleming has drawn attention to the depressing fact that instrument researchers, even if they are experts, seem unable to duplicate each other's measurements with any exactitude. He concludes from several examples that the inherent variation hovers around 1 percent.⁴⁹ The illustrations for this article are somewhat more accurate than this, at least for the longer measurements. But be this as it may, the reader will appreciate that the conclusions presented here neither stand nor fall on a millimeter or two in any direction.

All of the drawings of instruments for this article began as direct pencil tracings of the antique viols. These were then digitized in the manner described below. Nothing in this technique is particularly original, but it represents a relatively new and certainly useful way to document musical instruments. It also lends itself very well to the preparation of full technical drawings.

Viol backs shown in the figures were traced onto a dimensionally stable drawing film using a simple tool that tracks along the sides of the instrument but does not introduce an error for the width of the drawing point. After tracing each back below the fold, the instrument was tipped at the fold and the shoulder outline traced. Thus, fold profiles are shown "unfolded," a reasonably common convention for drawing viols. Where there was ambiguity due to bulges or lack of verticality in the sides, I attempted to trace the back rather than the side outline. I traced the viol tops by carefully tacking a sheet of drawing film directly to the belly. This necessarily introduces an over-the-arch error of about 4 mm in width which was corrected by straight-line measurements taken at the corners, soundholes, and other prominent points.

Scales were marked on all these tracings using a standard 610 mm steel bar. The original tracings were then digitized at exactly 1:1 into .TIFF format using a professional KIP 9000 scanner. I brought these scans into Adobe Illustrator, where I rechecked scale, oriented the center joins of the viol plates to an exact vertical, and redrew the viol outlines in vector format. This is largely

⁴⁹ Fleming, "Viol-Making in England," 56–59.

done with a bezier tool in short sections at extreme magnifications and introduces little or no additional error. I drew soundholes from digital photographs imported into Illustrator and checked for position and scale using the scanned tracing and direct measurements. I drew any other features, the soundpost plate for example, from direct measurements.

The resulting outlines make it possible not only to make a dispassionate comparison of the shape of two viols overlaid in the same visual space, but to investigate their left-right symmetry through a mirror copy of the digital outline. Such outlines can also easily be used for geometrical analysis, and any proposed geometry can be drawn with pitiless accuracy, eliminating the sort of wishful thinking that I, at least, have sometimes fallen into with pencil-and-compass methods. The ability to scale one outline relative to another by a precise amount also makes it possible to compare the *shape* of one instrument to another regardless of size, something hardly possible with traditional pen and ink. A final advantage is that digital vector images are small, can readily be shared with colleagues in e-mail, and can be printed anywhere on industry-standard equipment.

This paper is dedicated to the memory of Professor James B. Caldwell (1938–2006), who first put a viol into my hands.

RECENT RESEARCH ON THE VIOL

Ian Woodfield

This bibliography is intended as a concise guide to recent research related to the viol. It lists books, articles, dissertations, selected reviews, published papers, and major scholarly editions of music. Research on any aspect of the viol (and related instruments such as the baryton) will qualify for inclusion. A sign of the changing times, this list incorporates an increasing number of on-line citations. Suggestions for additional entries in any language would be most welcome. They should be sent to Ian Woodfield, School of Music, Queen's University Belfast, Belfast BT7 1NN, Northern Ireland, or e-mailed to <i.woodfield@qub.ac.uk>.

Aranburu, Ander Arroitauregi. "A Soundposted Renaissance Viol." *The Viol* 15 (Summer, 2009): 13–16.

Ashbee, Andrew. "An Inventory of DK-Kk, Cl, 10; mu 6403 2402." *The Viola da Gamba Society Journal* 2, part 2 (2009): 15–55. (<http://www.vdgs.org.uk/publications-Journal.html>)

Berget, Clare. "Laurence Sterne, Charles Frederick Abel and the Viol." *The Viola da Gamba Society Journal* 2 (2008): 67–75. (<http://www.vdgs.org.uk/publications-Journal.html>)

Blacker, C. V. R., and David Pinto. "Desperately Seeking William: Portraits of the Lawes Brothers in Context." *Early Music* 37 (2009): 157–74.

Cyr, Mary. *Essays on the Performance of Baroque Music: Opera and Chamber Music in England and France*. Aldershot: Ashgate, 2008.

Dunford, Jonathan. "A Portrait of the Musician Marin Marais by Jean Dieu dit Saint-Jean in the Museum in the Chateau of Blois." Trans. Robert A. Green. *Journal of the Viola da Gamba Society of America* 44 (2007–8): 5–12.

- Gartrell, Carol.** *A History of the Baryton and Its Music: King of Instruments, Instrument of Kings*. Lanham, MD: Scarecrow Press, 2009.
- Hoffmann, Bettina.** “The Nomenclature of the Viol in Italy.” Trans. Richard Carter and John Steedman. *The Viola da Gamba Society Journal* 2 (2008): 1–16. (<http://www.vdgs.org.uk/publications-Journal.html>)
- Holman, Peter.** “Laurence Sterne the Musician.” *The Viola da Gamba Society Journal* 2 (2008): 58–66. (<http://www.vdgs.org.uk/publications-Journal.html>)
- Howard, Alan.** “Manuscript Publishing in the Commonwealth Period: A Neglected Source of Consort Music by Golding and Locke.” *Music & Letters* 90 (2009): 35–67.
- Iden, Mary, with John Topham.** “VdGS Meeting Report: Restoring the Kessler Collection of Viols, London, November 2008.” *The Viol* 13 (Winter 2008–9): 10–18.
- Liedmeier, Gesina, and Michael Latcham.** “Two Bass Viols Labeled John Roos at the Gemeentemuseum, The Hague.” *Galpin Society Journal* 62 (2009): 167–81.
- Mullen, Michael.** “The Pardessus de Viole and Quinton—A History.” *The Viol* 14 (Spring, 2009): 10–14.
- “Some Viol-Related Manuscripts and Printed Music in the RCM Collection.” *The Viol* 14 (Spring, 2009): 19–21.
- Myers, Herbert.** “Renaissance Viol Tunings: A Reconsideration.” *Journal of the Viola da Gamba Society of America* 44 (2007–8): 13–40.
- Ng, Shaun K. F.** “Réponce de Monsieur Rousseau.” *The Viola da Gamba Society Journal* 2, part 2 (2009): 56–74. (<http://www.vdgs.org.uk/publications-Journal.html>)
- Robinson, Andrew.** “Narcissus Marsh’s Viol Manuscripts and Musical Investigations.” *The Viol* 15 (Summer, 2009): 17–20.
- Robinson, John H.** “John Leyden’s Lyra Viol Manuscript in Newcastle University Library and George Farquhar Graham’s Copy in the National Library of Scotland.” *The Viola da*

Gamba Society Journal 2 (2008): 17–57. (<http://www.vdgs.org.uk/publications-Journal.html>)

Sandmeier, Rebekka. “Stilistischer Paradigmenwechsel oder Generationenkonflikt?: Die Gambensonaten von Johann Sebastian und Carl Philipp Emanuel Bach.” *Archiv für Musikwissenschaft* 65 (2008): 213–224.

Sutcliffe, Richard. “The Pardessus Book of Mademoiselle Rochette.” *The Viola da Gamba Society Journal* 2, part 2 (2009): 1–14. (<http://www.vdgs.org.uk/publications-Journal.html>)

Topham, John. “The Restoration of a Swedish Viol.” *The Viol* 13 (Winter 2008–9): 28–36.

Turbet, Richard. “Byrd’s Choral Songs with Viols.” *The Viol* 9 (Winter 2007–8): 14–16.

——— “A Note on Dating Two Anthems by Byrd.” *The Viol* 14 (Spring, 2009): 17.

Wells, Elizabeth, and Christopher Nobbs. *Museum of Instruments Catalogue, Part III: European Stringed Instruments*. London: Royal College of Music, 2007.

Whittaker, James V. “A Thematic Index from the Stone Age.” *The Viol* 9 (Winter 2007–8): 18–21.

REVIEW

Joseph Haydn. *24 Divertimenti a tre für Baryton (Viola da Gamba, Violine) Viola und Violoncello*; Hob. XI: 73–96 (Band IV des Haydn-Verzeichnisses). Edited by Günter and Lenore von Zadow. Heidelberg: Edition Güntersberg, 2009. Score €36.00; parts: Baryton (Violin)—treble clef, Baryton (Viola da gamba)—alto clef, Viola, Violoncello, €19.80 each.

Joseph Haydn. *28 Divertimenti a tre für Baryton (Viola da Gamba, Violine) Viola und Violoncello*; Hob. XI: 97–126 (Band V des Haydn-Verzeichnisses). Edited by Günter and Lenore von Zadow. Heidelberg: Edition Güntersberg, 2009. Score €44.00; parts: Baryton (Violin)—treble clef, Baryton (Viola da gamba)—alto clef, Viola, Violoncello, €23.50 each.

Anyone wanting to play Haydn's 126 charming and masterful baryton trios,¹ composed at the behest of his baryton-playing patron, Prince Nikolaus Esterházy, immediately faces two logistical obstacles: first, obtaining a baryton on which to play; second, obtaining copies of the music from which to play.

Although the baryton, with its combination of plucked and bowed strings and formidable playing technique, remains (as it was in Haydn's day) a relatively uncommon instrument, the first obstacle can be readily—at least temporarily—avoided, inasmuch as almost all of the trios can be performed quite satisfactorily with either viola da gamba or violin substituted for the baryton. Indeed, only about one in three of the trios, as they have come down to us, use the plucked strings of the baryton at all.² In the remaining trios, the instrument becomes essentially identical to a bass viola da gamba, since the bowed strings of the two viol-family instruments are tuned identically. Many of the trios also circulated in eighteenth-century manuscripts with the solo part designated for viola da gamba or for violin, either as an alternative to the baryton or, in

¹ The baryton trios (called “divertimenti” by Haydn, the title he used for most of his early chamber-music works) are mostly scored for baryton, viola, and cello; three are for baryton, violin, and cello.

² In the publications here under review, the proportion is even smaller: just two among trios 73–96 and three among trios 97–126 use the baryton's plucked strings.

many cases, even without mentioning the possibility of using a baryton at all.³

Since Haydn notated his baryton parts in treble clef, sounding an octave lower than written (a notation used elsewhere in the late eighteenth century for soloistic parts both for viola da gamba and for cello), the violin can readily play from the same notation, sounding in its own register at the notated pitch. Passages in which the octave transposition leads to serious voice-leading problems are surprisingly rare, mostly coming where plucked notes supply a bass line to the other instruments' parts—but even then the inversion causes far fewer problems than one might anticipate, and perhaps nothing worse than Haydn's own notorious habit of occasionally creating second inversions by writing the viola part below the bass in his chamber music.⁴

The trios are more effective with the violin playing the baryton part an octave higher than with a second viola playing the part at the baryton pitch, as one might be tempted to try. This is the case both because the baryton parts would lie mostly on the middle strings of the viola, not using the full resources of the instrument to best effect, and also because the timbral distinction between baryton and viola plays a large role in the effectiveness of the scoring when they are played in the same octave. The timbral distinction (or, with the baryton part on violin, the octave distinction) comes particularly into play in the minuets, where the baryton and viola are often given the minuet melody in unison while the cello plays the bass, producing a striking, almost orchestral sonority; Haydn saves three-part texture for the trios of these minuets

³ One such manuscript, from the collection of the Gesellschaft der Musikfreunde in Vienna, contains the baryton part of forty-seven trios under the title "Divertimenti a viola da gamba principale...." A photograph of its title page is reproduced in the front matter of the Edition Güntersberg score of divertimenti 97–126.

⁴ In "The Bass Part in Haydn's Early String Quartets," *Musical Quarterly* 63 (1977): 390–424, James Webster refutes at length earlier arguments that these inversions imply the use of some kind of contrabass instrument sounding an octave lower than the notation, rather than the cello, in Haydn's early chamber works (including the baryton trios). For more about the bass and contrabass stringed instruments available to Haydn, see the same author's "Violoncello and Double Bass in the Chamber Music of Haydn and His Viennese Contemporaries," *Journal of the American Musicological Society* 29 (1976): 413–38.

(which thus literally become trios), paradoxically producing a more transparent, chamber-music quality by employing more voices.

Facing the second obstacle, it has to be said that the prospects of obtaining copies of Haydn's baryton trios have improved considerably since the early decades of the twentieth century, at which time the composer's baryton music was generally thought to have been lost entirely, or nearly so, surviving chiefly as brief thematic incipits preserved in the catalogs of Haydn's works prepared or supervised by Haydn during his lifetime.⁵ The American musicologist Oliver Strunk corrected this misimpression in 1932, pointing out not only that at least 111 trios were known to him to have survived (either in their original scoring or in arrangements) but also that sources for a majority of the trios had found their way to America in eighteenth- and nineteenth-century manuscript copies once owned by Louis Picquot, the mid-nineteenth-century biographer of Boccherini, that had been acquired by the Library of Congress in 1906.⁶

Looking for practical performance material, one might be fortunate enough to come across copies of the three long-out-of-print volumes of baryton trios published in the mid-twentieth century by the prolific early-music editor Waldemar Woehl.⁷ These pro-

⁵ Both the so-called "Entwurf-Katalog" ("draft catalog") largely in Haydn's own hand and the later "Haydn-Verzeichnis" ("Haydn Catalog") prepared for him by Johann Elssler are reproduced in Jens Peter Larsen, *Three Haydn Catalogs, 2d facsim. ed. with a new survey of Haydn's oeuvre* (New York: Pendragon Press, 1979) and in its earlier edition *Drei Haydn Kataloge* (Copenhagen: Einar Munksgaard, 1941).

⁶ Oliver Strunk, "Haydn's Divertimenti for Baryton, Viola, and Bass (After Manuscripts in the Library of Congress)," *Musical Quarterly* 18 (1932): 216–51. In addition to presenting his own research, Strunk also reports on then-unpublished information from European researchers, most notably including Eusebius Mandyczewski (1857–1929). Strunk accepts as authentic the first of two probably spurious trios (Hob. XI:D2 and XI:A1; the second was unknown to Strunk). This trio is attributed to Haydn in the ex-Picquot manuscripts but unattributed in another source that was unknown to him. See Anthony von Hoboken, *Joseph Haydn: Thematisch-bibliographisches Werkverzeichnis* (Leipzig: B. Schott's Söhne, 1957), 1:658.

⁷ Joseph Haydn. *Divertimenti für Baryton, Bratsche und Bass*, ed. Waldemar Woehl, 3 vols. (Basel: Bärenreiter, 1939–1952) (Hortus Musicus 65, 94, 95). The three volumes respectively contain the divertimenti Hob. XI nos. 26, 35, 45; 30,

vide parts for nine trios in all—prudently (though also optimistically) including just one trio using the plucked strings as the final selection in each volume.

For the rest of the trios, one goes to any fair-sized music library, locates the composer's complete works in the "new" critical edition,⁸ and scans the shelves for the six consecutive volumes whose pristinely clean spines betray the fact that they have been sitting there virtually unopened since the library bought them. These will be the works for baryton:⁹ five volumes of trios, corresponding both to the sets of manuscript partbooks into which the trios were collected during the composer's lifetime and to the groupings in Haydn's own catalogs of his works,¹⁰ plus a sixth volume of works for baryton with other combinations of instruments.¹¹ All have been scrupulously edited with extensive critical commentaries based on a study of all surviving sources. The music is beautifully hand-engraved on metal plates by the last surviving publishing house to use that method of music origination, but published—here is the rub—in score only. There are no parts available, nor have the scores been laid out with any view to facilitating page turns. So aside from the Woehl edition, or possibly some of the various editions that have been adapted for string trio and pub-

25, 44; 27, 25, 48. Hortus Musicus 65 was originally issued as Bärenreiter-Ausgabe 1431 and only subsequently included in the Hortus Musicus series, which was established in 1950. Note that the nine trios in the Woehl edition are not duplicated in the two volumes here being reviewed.

⁸ *Joseph Haydn, Werke*, ed. Joseph Haydn-Institut, Cologne (Munich: Edition Henle, 1958–).

⁹ I am indebted to John Hsu for this exceptionally efficient method of locating the baryton works.

¹⁰ *Werke*, Reihe XIV: *Barytontrios*. Vol. 1 ed. Jürgen Braun and Sonja Gerlach (1980; includes *Kritischer Bericht* [Critical Commentary] in the same volume); vols. 2–4 ed. Hubert Unverricht (respectively 1960, 1958, 1958, separate *Kritischer Bericht* volumes issued 1964, 1959, 1961); vol. 5 ed. Michael Härting and Horst Walter (1968, *Kritischer Bericht* 1969). The first four sets contain precisely 24 trios each, probably composed mostly in sets of six. (See Gerlach, "Vorwort" to *Werke* XIV:1, p. [VII].) The fifth set seems to be a less tidy assemblage of the trios remaining to be collected after Prince Nikolaus had lost interest in the baryton. (Walter, "Vorwort" to *Werke* XIV:5, p. [VII].)

¹¹ *Werke*, Reihe XV: *Werke mit Baryton*, ed. Sonja Gerlach (1969, *Kritischer Bericht* 1970). See also Gerlach, "Neues zu Haydns Baryton-Oktett Nr. 5 (Hob. X:1)," *Haydn-Studien* 5 (1982): 125–34.

lished here and there over the years (usually with quite unsuitable editing), the aspiring barytonist has heretofore had to rely on his or her own aptitude for photocopying, cutting and pasting, hand copying, data entry, or scrounging performance materials from others who have gone before—to the extent that others may have been willing to risk incurring the wrath of publishers by sharing materials derived from editions protected by copyright. Barytonists, and even violists da gamba, may have been sufficiently motivated to take these steps, but to string trios (violin, viola, cello)—especially to student and amateur string trios who might greatly benefit by having this beautiful and technically quite manageable music readily available in reliable editions—it has remained largely inaccessible.

Into this gap now steps the small music publisher Edition Güntersberg, already known for its high-quality practical editions of early music, including many titles for viola da gamba. Following the general approach of this publisher, the Güntersberg editors have gone to the sources and created an edition that is designed to be legible and easy to use, while remaining as free as possible from editorial interventions and additions. This approach, carried out logically and consistently, produces a musical text that is rather deliberately different from that of the collected-works edition.

Like the collected-works edition, the Güntersberg edition presents each trio on a single “best-text” source, usually incorporating readings from other sources only in case of manifest error in the principal source. The collected-works edition, however, also supplies additional articulation signs (slurs and staccato markings). These come occasionally from other sources (within parentheses), but also quite abundantly (within square brackets) wherever the editors have judged them to be musically necessary or advisable, usually on the basis of parallel passages that bear articulation signs in the sources. The Güntersberg editors (who are also, as it happens, the founders of the publishing house) have refrained from both these kinds of additions, quite deliberately putting the users of their edition into very much the situation in which eighteenth-century musicians habitually worked: using a single source, and fleshing out the invariably incomplete indications of bowings and articulations by using their musical taste, training,

and instincts—and, not least, by using their ears, listening to the other parts.

Although in theory such an approach forces the user to consult the collected-works edition and its extensive editorial apparatus in order to get the full picture of the articulations that have been transmitted to us, in practice such consultation tends to yield very few substantive results. Added articulations taken from additional sources will mostly be either obvious emendations or extensions of bowings to parallel passages (in either case therefore both readily supplied by ourselves and reasonably likely not to have originated with the composer's autograph), and as for the additions on the editors' initiative in the collected-works edition, when they are not obvious they may in some cases be a bit overzealously abundant and musically unnecessary.¹² Seeing them in the parts on a first reading, even within the editors' square brackets, can easily lead us to unwittingly incorporate them permanently into our conception of the piece and to prevent us from finding other, perhaps even better, musical solutions.¹³ A further point in favor of Edition Güntersberg's strict non-interventionist approach to articulation

¹² The different editors of the various volumes of the complete works, while all following the same overall editorial guidelines established for the edition, nonetheless seem to vary in their readiness to add additional marks on their own authority—and predictably so, since such decisions must by their nature depend very much on the individual editor's judgment. With the differences among editors layered on top of the already quite variable degree of completeness of articulation markings in the sources, players face a more complicated task than they might realize in deciding what articulations to use. Where the sources are as vexingly complicated and uneven as they are for Haydn's baryton trios, even the most assiduously prepared edition cannot reasonably be expected to provide ready-made, ready-to-play markings that will be both philologically defensible and to all players' tastes.

¹³ For example, the editors' slurs in the last measure of each section of the Polonaise in the collected-works edition of Trio 97 are not necessarily justified as parallel to the other slurred sixteenth notes in the movement, since the shape of the four-sixteenth-note figure is different. (This is the first trio in vol. 5, which seems particularly rich in editorial suggestions of articulation signs.) I had been playing those slurs for more than a decade when the cellist David Bakamjian spotted the square brackets during a rehearsal and kindly pointed out to me that the slurs could be omitted to good musical effect. It is greatly to the credit of the Haydn-*Werke* edition that its added articulations are always clearly identified on the page, making constant reference to the separate textual apparatus unnecessary.

markings is the growing body of evidence that suggests that uniformity of articulation in reoccurring musical phrases or figures was neither always expected nor necessarily considered desirable in the eighteenth century.¹⁴

As the Edition Güntersberg editors explain in the very informative prefaces of the two volumes thus far issued, these two volumes differ very much in the nature of their source manuscripts. For volume 4, we have a complete set of bound manuscript parts beautifully copied by Joseph Elssler, the founder of a father-and-sons dynasty of Esterházy and Haydn copyists, and the editorial process is therefore relatively straightforward. One highlight of this volume is Divertimento 87 in A minor,¹⁵ with its pathetic yet cantabile first movement, an energetic and challenging *Allegro di molto* main movement in $\frac{2}{4}$, and a vigorous concluding minuet with a ländler-like trio. (Witty and engaging minuet movements as only Haydn could write abound in the baryton trios—often as the third and final movement.)

For volume 5, there is no single complete source. The “best” sources for the individual trios vary in reliability, from excellent copies and even Haydn’s autograph manuscripts in a few cases, to distantly removed publishers’ transposed arrangements for flute, violin, and cello.¹⁶ Nonetheless, some of Haydn’s most engaging

¹⁴ See, for example, James Webster, “The Triumph of Variability: Articulation Markings in the Autograph of Sonata No. 49 in E Flat” in Sigard Brandenburg, ed., *Haydn, Mozart, and Beethoven: Studies in the Music of the Classical Period in Honour of Alan Tyson* (Oxford: Clarendon, 1998). See also Dene Barnett, “Non-uniform Slurring in 18th-century Music: Accident or Design?” *Haydn Jahrbuch* 10 (1978): 179–99.

¹⁵ This is one of only two of the 126 divertimenti composed in a minor key—evidently they were not to the prince’s taste! The other minor key trio, no. 96 in B minor, is also in this volume. In fact, the prince’s taste (or his technical facility) in major keys seems to have been fairly limited as well: most of the trios, including all that make use of the baryton’s plucked strings, are in A major, D major, or G major. Outside of these three tonalities are seven trios in C major, four in F major, the two minor-key trios already mentioned, and an occasional excursion to the parallel minor for the trios of some of the minuets.

¹⁶ Complete manuscript copies also survive for the second and third volumes of baryton trios. They are not the original Elssler fair copies as with volume 4, but apparently derive from the lost Elssler copies, with some loss of accuracy in transmission, notably as concerns articulation marks. For volume 1, the situation is comparable to volume 5, though with an overall even less reliable assortment

music for baryton trio is in this volume. It opens with the seven-movement Divertimento 97, composed for the prince's birthday.¹⁷ Three of the trios have *alla breve* fugal finales that echo, on a slightly smaller scale, the similar movements of the string quartets of Haydn's op. 20.¹⁸ The cello parts are particularly interesting in these last trios: in addition to its thematic participation in the fugal movements, the cello gets some prominent solo work in three sets of variations (used as the first movement of their respective trios—a fourth such variation movement, alas, overlooks the cello). On a practical note, in the trio of the minuet of Divertimento 107, where the baryton, uniquely in Haydn's preserved baryton works, plays alone while accompanying the bowed melody with a complete bass line played simultaneously on its plucked strings,¹⁹ the editors have thoughtfully cued the bass line into the cello part in small notes. This makes the movement playable with violin or viola da gamba, and it will also come as a considerable relief to aspiring barytonists whose facility plucking with the left thumb on the baryton's "lower manual" is closer to

of sources, notably as concerns articulation marks. The sources are described in great detail and fully evaluated in the critical commentaries cited above in note 10. See also Gerlach in *Werke* XIV:1, p. VIII for a brief assessment of the relative reliability of the sources for volumes 1 and 5.

¹⁷ Apart from no. 97 the trios are all in three movements with the exception of nos. 1 and 2, which are in four movements. (No. 2 also exists in a version with three movements that, although it survives only in arrangements, may in fact reflect an earlier three-movement version for baryton trio. See Gerlach in *Werke* XIV:1, pp. IX and 152, for her reconstruction and evaluation of the rather complicated relationships among the sources of this trio.) In any event, the trios are works of modest scale, with individual movements only occasionally exceeding a hundred measures in length and indeed with a handful of movements as short as two dozen measures or fewer.

¹⁸ Walter in *Werke* XIV:5, p. VII.

¹⁹ Simultaneously playing melody and bass in this manner—usually with a larger and lower-pitched assortment of plucked strings than the Esterházy instruments possessed—was the norm for the baryton in its historical repertoire from the seventeenth century to the early nineteenth, both in unaccompanied playing and in the very small surviving repertoire of ensemble music from outside of the Esterházy circle. For the Esterházy baryton repertoire other than Haydn, the indispensable study remains Efrim Fruchtmann, *The Baryton Trios of Tomasini, Burgksteiner, and Neumann* (Ph.D. dissertation, Univ. of North Carolina at Chapel Hill, 1960).

that of the noble amateur Prince Nikolaus than to that of the touring baryton virtuosi of the seventeenth and eighteenth centuries.

Overall, my impression is that by the end of his involvement with the baryton Haydn is well on his way toward what he would call the “*gantz neue besondere Art*” (completely new special manner) of his string quartets op. 33 (composed 1781)—and that one can, over the course of the creation of the five volumes of baryton trios, starting perhaps before 1765 and extending to about 1774,²⁰ quite literally peer into the workshop in which Haydn was, brick by brick, building the Classical style that the world would come to know.

The Güntersberg edition is laid out with the needs of players foremost in mind. The baryton part is published both in the original treble clef (to be read an octave lower on baryton or at pitch on violin) and in alto clef (which some violists *da gamba* may prefer). There are no bad page turns in the parts—indeed, there are no page turns within movements at all. Even the score avoids page turns within movements where possible and, where this is not possible, almost always manages to place them at double barlines (repeat marks). However, only the sharpest-eyed players would be happy playing from the score due to the relatively small staff size necessary to fit this enlightened layout onto the A4-sized pages of the edition. The score remains, however, an invaluable aid to preparing performances, particularly to a barytonist (such as myself) who is just old-fashioned enough to want some time to look over not only the musical invention but also the bowing indications in advance of rehearsal and perhaps, in the interest of both time and art, to pencil a few suggestions for his colleagues before starting to work.

In an ideal world—one in which the economic constraints that face a small music publisher with a specialized clientele did not exist—I would have liked to see both parts and score in a slightly larger format, as is usual with chamber music parts from major publishers—found for example, in the Haydn string quartet editions from Henle (based on the Joseph Haydn-Institut collected-works edition) or Peters (whose recent and forthcoming urtext editions of the quartets include newly edited critical scores

²⁰ Gerlach in *Werke* XIV:1, p. VII.

along with their parts). I would also greatly have preferred stitched or saddle-stapled bindings, as used by Henle and Peters, to the necessarily somewhat fragile and easily bent wire-comb bindings that Edition Güntersberg has used.

The publishers have thoughtfully—and shrewdly—made one entire three-movement trio from each of the two volumes available for free download from their bilingual German and English website (www.guentersberg.de). The editors' introductions from both volumes are downloadable as well. The website also reports errata and addenda that have been discovered and incorporated in the masters that will be used for any reprintings: as of this writing, just a single misprint in the cello part of *Divertimento* 123. The only additional error that I have so far encountered is an obviously mislocated time signature in the baryton partbooks: at the trio of the minuet of *Divertimento* 96, the $\frac{3}{4}$ marking should clearly come at the beginning of the first strain, not the second.

This edition deserves to be well received not only by gambists and barytonists but by string trios as well. It will be particularly welcome for use by less-advanced amateur and student violinists, since the baryton parts lie mostly within the limits of first position on the violin and never go above third position. Viola players will be pleased by the consistently interesting and occasionally quite soloistic parts for their instrument, which likewise remain within the first three positions. I can report that when I took these parts to read with an amateur string trio, their immediate reaction was “this is fantastic music—where can I buy this?” One could not, I think, ask for a more engaging and approachable repertoire with which to initiate young players into the style of classical chamber music—or, indeed, with which to tempt gambists into exploring the very last repertoire that their instrument acquired before the revival of the past 125 years. Above all, I hope that it succeeds sufficiently well to encourage Edition Güntersberg to bring out the remaining three volumes of Haydn's baryton trios in this very useful form.

Roland Hutchinson

CONTRIBUTOR PROFILES

Roland Hutchinson plays baryton with the London-based Hauschka ensemble, with whom he has recorded the complete Haydn baryton duets and trios for two barytons and cello and performed both the music of Haydn and new works for baryton duet by British and American composers in concerts in the U.S., Canada, Britain, Germany, the Netherlands, Austria, and Hungary. He lives in northern New Jersey, where he promotes viol playing, performs on viola and violin, teaches violin on the faculty of New Jersey City University, and dabbles in composing neo-Georgian psalmody for the edification of his many singing friends.

Thomas Mace is a full-time maker of viols and Baroque violins. He concentrated on early music as an undergraduate at Oberlin College and went on to study musical instrument conservation and organology at the Germanisches Nationalmuseum in Nürnberg under Friedeman Hellwig and John Henry van der Meer. He also has a master's degree in historical musicology from Columbia University, where he studied with Richard Taruskin. In his work as a maker, he strives to use historical techniques to make precise copies of antique instruments that look and sound as the originals would have when new.

Joëlle Morton is an active performer and teacher throughout the U.S., Canada, Brazil, and Europe. In addition to numerous performing affiliations, she is artistic director for the Scaramella concert series in Toronto, where she also coordinates the Pastime With Good Company viola da gamba workshop series, teaches viola da gamba at the University of Toronto, and directs a viol consort as ensemble-in-residence at the Church of St. Mary Magdalene. She is also much in demand as a musicologist and clinician, lecturing on the performance practice and the history and development of string instruments. She is the author of a number of scholarly articles and has published several editions of music for lyra viol. Her website (www.greatbassviol.com) serves

as an important international resource for those interested in researching large bowed bass instruments.

Ian Woodfield received his bachelor's degree from Nottingham University and his master's and doctorate from King's College, University of London. He was Herschel Fellow at Bath University in 1976–77. In 1978 he was appointed to the music faculty of Queen's University Belfast, where he is now Director of the School of Music. His first book, *The Celebrated Quarrel Between Thomas Linley (Senior) and William Herschel: An Episode in the Musical Life of 18th-Century Bath*, was published by the University of Bath in 1977. He has also contributed articles and reviews to *Early Music* and the *Proceedings of the Royal Music Association*. His book *The Early History of the Viol* (published by Cambridge University Press in 1984) is now a classic on the subject. He delivered two lectures at the 1994 VdGSA Conclave. He has recently published two books: *Music of the Raj* (Oxford University Press, 2000) and *Opera and Drama in Eighteenth-Century London* (OUP, 2001).